

---

## ODiSI Fiber Optic Sensor Installation Guide

### Contents

1. Introduction .....	1
2. Contents of Fiber Optic Sensor Installation Kit .....	2
3. Mounting the Strain Sensor .....	2
3.1. Planning the Sensor Route .....	2
3.2. Surface Preparation .....	3
3.3. Laying Down the Sensor in the Designed Route .....	4
3.4. Fiber Bonding .....	4
4. Additional Tips.....	6
5. Supplementary Considerations .....	7
5.1. Surface Preparation .....	7
5.2. Adhesive Selection .....	8
5.3. Adhesive Application .....	8
6. References.....	8
7. Product Support Contact Information .....	9

### 1. Introduction

This Application Note is intended to guide users of Luna’s High Definition Fiber Optic Sensing (HD-FOS) system (the ODiSI) through the simple process of mounting a fiber sensor onto the surface of a test article. The process of mounting the fiber optic strain sensor is very similar to the process for mounting electrical foil strain gages. The same surface preparation methods are used and similar adhesive selection considerations are made. This Quick Start Guide accompanies a Fiber Optic Sensor Installation Kit that can be purchased from Luna (P/N: FOSAPPKIT). This sensor installation kit is intended for the bonding down of 10 m of Luna’s fiber optic sensor onto a relatively smooth metallic or composite surface. This can be composed of multiple short sensors or a single long sensor. The adhesive used here is Micro Measurements’ M-Bond 200 epoxy, which is a single part cyanoacrylate that provides strong adhesion with rapid room-temperature cure times, and is suitable for short term applications. The manufacturer’s published short term operating temperature range is -185°C to 95°C, and long term operating temperature range is -32°C to 65°C.

## 2. Contents of Fiber Optic Sensor Installation Kit

The contents of the sensor installation kit are listed below, along with the intended use of each item.

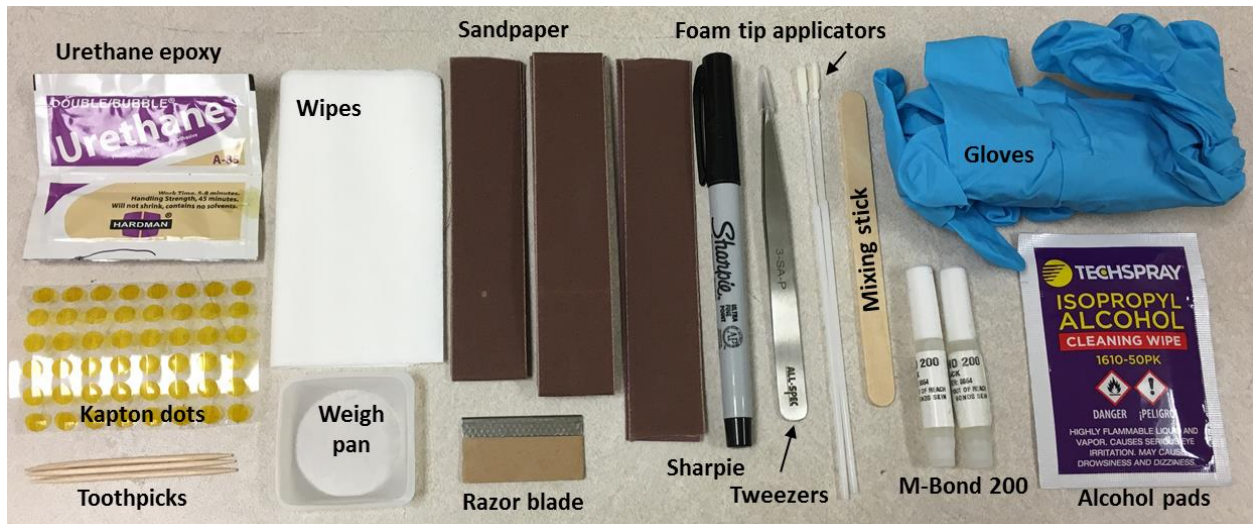

Figure 1: Contents of the sensor installation kit.

Table 1: Contents of fiber optic sensor installation kit.

Item	Quantity	Use
Gloves (size L)	2 pairs	Skin and surface protection
220 grit sandpaper	60 cm	Surface preparation
400 grit sandpaper	60 cm	Surface preparation
600 grit sandpaper	60 cm	Surface preparation
Alcohol pads	6	Surface cleaning
Wipes	2	Surface cleaning
Fine tip sharpie	1	Marking the sensor route
Tweezers (stainless steel)	1 pair	Tape dot application (not fiber sensor handling)
Kapton tape dots (1/4")	100	Fiber routing: 1 tape dot every 30 cm
Razor blade	2	Cutting epoxy tube
Foam tipped applicators	10	Epoxy application: 1 foam tip per 1 m of sensor
M-Bond 200 epoxy (2g tube) <sup>1</sup>	2	Fiber bonding
Urethane epoxy	1 packet	Bonding fiberglass-sheathed sensor lead
Weigh pan	1	Mixing urethane epoxy
Mixing stick	1	Mixing urethane epoxy
Toothpicks	5	Applying urethane epoxy

## 3. Mounting the Strain Sensor

### 3.1. Planning the Sensor Route

The ODISI provides strain measurements along the entire length of a fiber sensor (up to 20 m long), at a millimeter-scale sensor spacing. These measurements are of strain in the direction of the fiber sensor. In certain applications, the spatially continuous strain profile is of interest due to the ability to measure

<sup>1</sup> The epoxy should be stored in a fridge and has a minimum shelf life of 12 months when stored unopened at 5°C.

strain gradients. In other applications, it is individual discrete locations along the sensor that are of interest. Therefore, in order to capture strain at the location(s) and in the direction(s) of interest on the test article, it is important to plan the sensor route accordingly. The following considerations should be applied to the design of the sensor route:

- The recommended short term sensor bend radius is 1 cm and the long term sensor bend radius is 2 cm
- It is recommended that the entire sensor be bonded to the test article. In the event that it is necessary to leave some fiber loops unbonded (e.g. to transition to different faces), the sensor loop should be not less than 6 cm long. The measurement point(s) of interest should be located at least 2.5 cm away from any bonded-to-unbonded transition regions or transition bends in order to mitigate strain transfer edge effects [Skontorp]
- It is often useful to design a sensor path that is symmetrical across a feature e.g. on the front and back surface of a part, or to the left and right side of a surface feature, indentation, or gage
- The termination should be located away from any high strain areas to preserve its quality and performance

Figure 2 provides a schematic drawing of a well thought out symmetrical sensor route on either side of a set of holes along a coupon.

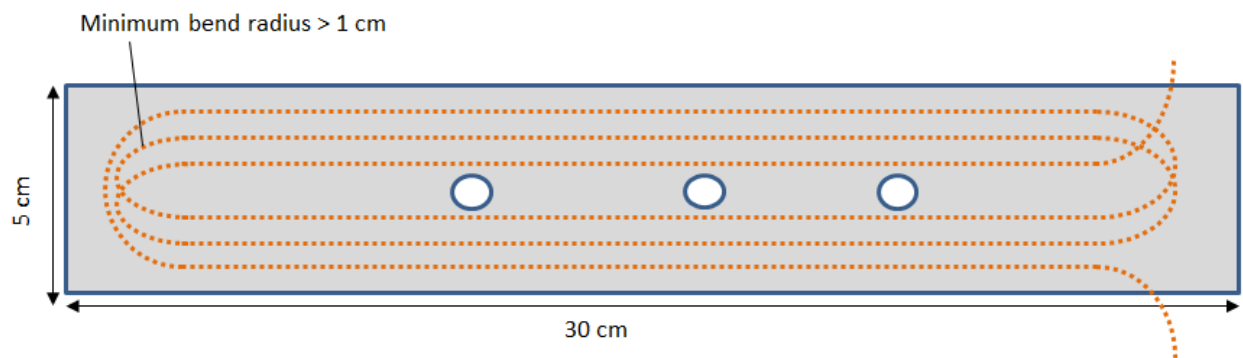

Figure 2: Schematic of sensor route along a coupon with holes.

### 3.2. Surface Preparation

The purpose of surface preparation is to develop a chemically clean surface with a surface roughness suitable for epoxy adhesion. It is important to ensure that no dirt, grease, or paint is left on the surface as this will compromise bond quality and ultimately strain transfer to the sensor. It is therefore good practice to always wear gloves when bonding down fiber sensors to prevent the transfer of skin oils to the surface.

1. Put on a pair of gloves.
2. Sand the surface where the sensor will be laid out with 220 grit sandpaper followed by 400 grit sandpaper. 600 grit sandpaper may be used on softer surfaces e.g. plastic. It is best to sand this area in multiple directions in order to create a cross hatch abrasion pattern, to facilitate adhesion.
3. Wipe down this area with alcohol wipes. These are single-use wipes that should not be reused. Do not wipe back and forth with the same wipe as this could result in contaminants being reintroduced to the surface.
4. Remove any alcohol residue from the surface with the wipes.

### 3.3. Laying Down the Sensor in the Designed Route

The next step is to tape down the fiber sensor in the desired layout across the test article, in a pattern as determined at the start of this process. Once completed, this process will result in the sensor being held down in place across the entire test article, ready for a quick application of the adhesive epoxy. For this step, Kapton tape dots are used to hold the fiber in place, as these do not leave a residue when removed from the surface. The fiber sensor is made of silica (glass) and while is strong in tension, is weak in shear. Therefore care needs to be taken to prevent the sensor from being wound into too tight of a loop, causing it to break. The fiber sensor is packaged on a spool for ease of shipping and handling. It should be noted that unless it is held down, the fiber will unravel. Therefore care also needs to be taken to manage the fiber on the spool in such a way as to minimize the possibility of unraveling.

1. Mark the test article with a sharpie to identify the sensor path on the test article.
2. The fiber will tend to unwind from the spool if not taped down. To prevent this, carefully unwind approximately 1 m of fiber from the sensor spool starting from the termination, while holding down the fiber against the spool the entire time. Re-tape the rest of the sensor back onto the spool.
3. Lay the termination on the surface. Use tweezers to pick up a tape dot and tape down the fiber sensor 2 cm from the termination (Figure 3A). Use your thumb or the tip of the tweezers to push the tape dot down to the surface (Figure 3B). Do not use the tweezers to handle the fiber sensor.

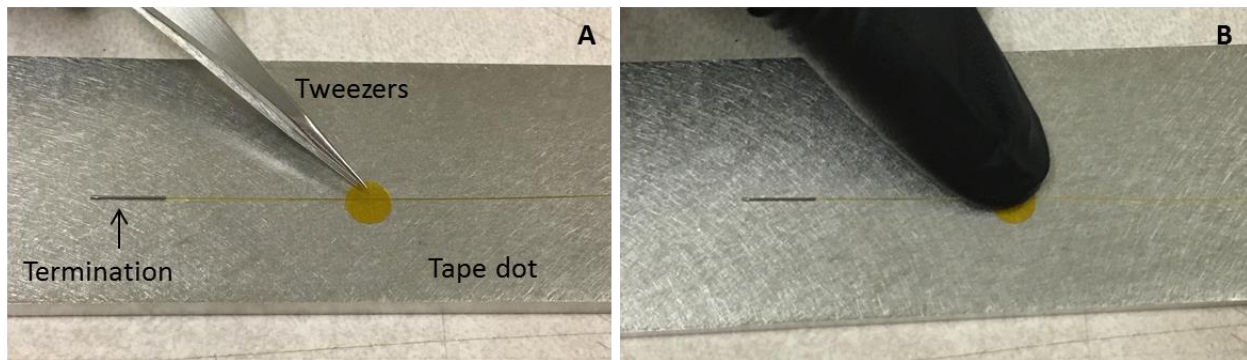

Figure 3: A. Tape down the fiber sensor starting from the termination. B. Use thumb to push the tape dot down to the surface against the fiber sensor.

4. Wipe down the unwound length of fiber sensor with an alcohol wipe.
5. Applying slight tension to the fiber, lay it down along the desired sensor path and hold it down with a tape dot at the next logical interval. For curved sections, this would be at an interval that maintains tension along the sensor while keeping it in the desired path. For straight sections, leave at most 30 cm between neighboring tape dots to prevent slack buildup.
6. Continue applying tape dots along the desired sensor path until you reach the sensor lead.

### 3.4. Fiber Bonding

The final step is to apply adhesive to the sensor and cure it onto the test surface. The bond line quality will ultimately determine the efficiency of strain transfer from the test article to the fiber sensor. As long as enough epoxy is used to cover the fiber sensor, the efficiency of strain transfer is not affected by excessive adhesive [Skontorp]. However the bond thickness (amount of epoxy between the fiber and the surface) should be minimized to ensure that the fiber is truly resting on the surface of the test article (Figure 4).

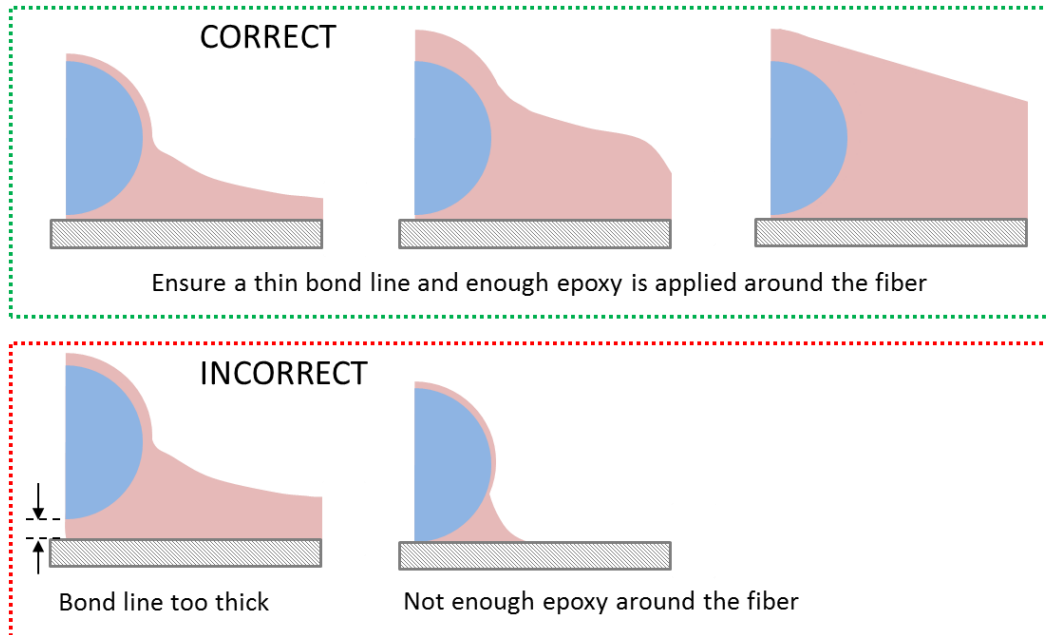
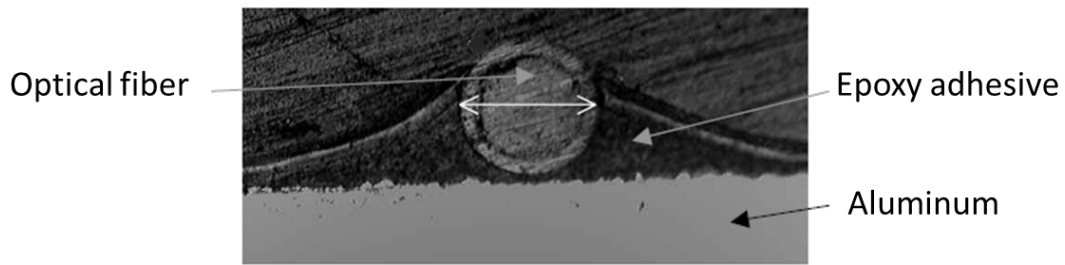

Figure 4: Optimal adhesive application around the fiber sensor cross section [Skontorp].

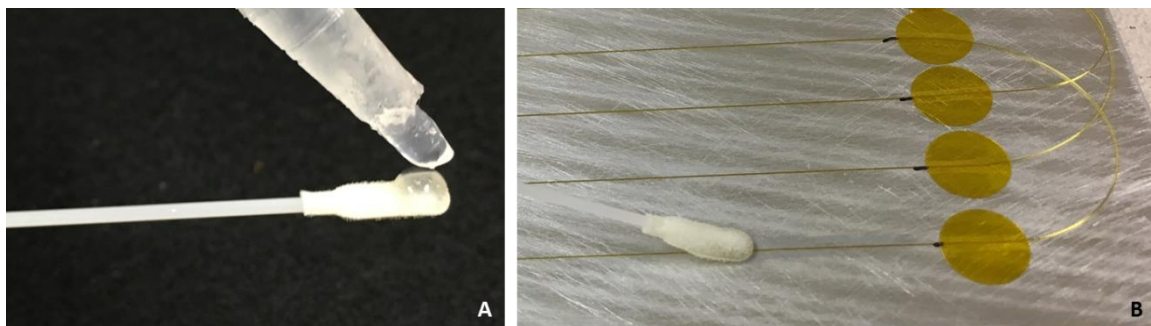

Figure 5: A. Load epoxy onto the foam swab. B. Drag foam swab along the fiber sensor to coat the sensor with epoxy.

1. Cut off the tip of the M-Bond 200 tube with a razor blade.
2. Squeeze the epoxy onto the foam swab until the foam is loaded with epoxy (Figure 5A).
3. Drag the foam swab down the exposed sections of sensor to coat the sensor with epoxy (Figure 5B).  
The minimum amount of epoxy needed for strain transfer is a meniscus around the sensor diameter.



However, internal testing has shown that the thickness of the epoxy layer covering the sensor does not affect measurement quality when the test piece consists of a stiff substrate.

4. Be sure to start and end the epoxy layer just before the Kapton dot (do not apply epoxy over the edge of the dot) to ease the process of peeling the dots off later.
5. Repeat the loading and dispensing of epoxy for approximately 1m of sensor.
6. Remove Kapton dots from the sensor segment and apply epoxy at these locations to fully coat the entire segment. It is advisable to fill in the Kapton dot spaces once the dots are removed while the epoxy is still wet to create a continuous line of epoxy and prevent the formation of dried epoxy lips that might create stress concentrations on the sensor.
7. Repeat steps 3-6 on the next segment of sensor until the entire sensor is coated with epoxy.
8. It is advisable to coat the entire sensor in epoxy to protect the sensor and to prevent unbonded loops from breaking due to a snag.
9. Leave the epoxy to air dry. This will take approximately 5 minutes.
10. The epoxy is cured once it is no longer tacky to the touch.
11. The supplied M-Bond 200 tubes are primarily single use tubes. If more epoxy is needed for using in the near future (1 week), wipe bottle spout clean and dry before replacing the cap to ensure a proper seal. Refrigeration after opening is not recommended [2].
12. Mix the urethane epoxy in the weigh pan. Apply a drop of urethane epoxy onto the end of the fiberglass-sheathed lead using a toothpick, to hold it in place on the test surface (Figure 6).
13. Apply a drop of urethane epoxy onto the last 2 cm of the sensor and over the sensor termination to hold it in place on the test surface.

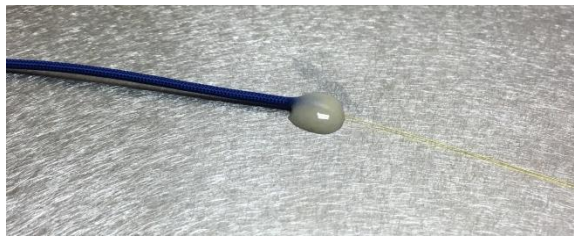

*Figure 6: Urethane epoxy holding down fiberglass-sheathed lead.*

14. Tape down the connector to the surface when transporting the test article to and from the test facility.

#### **4. Additional Tips**

The following tips may be helpful when laying down complex sensor paths:

1. It is easy to bond the fiber sensor onto flat or convex surfaces as slight tension can be applied to the fiber in order to ensure that it lays flat against the surface. However concave surfaces are more challenging to instrument, as tension applied to the fiber will pull it off the surface. Therefore the fiber should be pushed into the concave surface before being taped down, and a higher density of tape dots should be used to hold the fiber in place. In addition, a Teflon sheet can be held down against the fiber to keep the fiber flush against the surface as the epoxy cures.

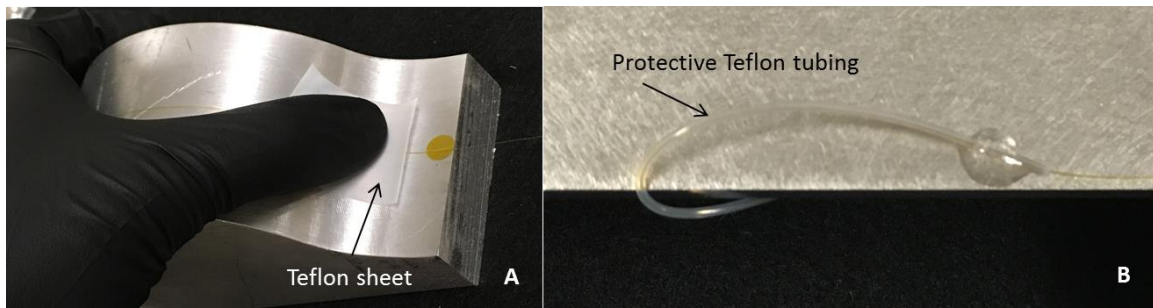

Figure 7: A. Hold the fiber sensor down against a concave surface while the adhesive cures. B. Teflon tubing protects a sensor that transitions from the top to the bottom surface.

2. The fiber sensor may need to traverse physical features such as dividers, be passed through holes, or transition from one surface to the next. In order to protect these sections of loose fiber from accidental breakage, Teflon tube can be slid over the fiber sensor and held down at these locations for added protection.
3. In some instances, it may be necessary to control the width of the bond line, for example when bonding to soft or thin substrates. This can be done by applying tape on either side of the fiber path and confining the adhesive within this channel (Figure 8).

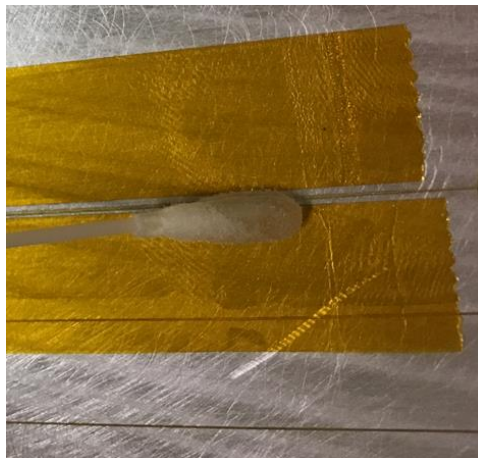

Figure 8: Dispensing epoxy into tape channel on either side of fiber sensor.

## 5. Supplementary Considerations

In addition to the material and steps described above, variations in surface type and test parameters will require additional considerations be applied to the bonding process. These include alternative surface preparation steps, adhesive selection, and adhesive application as listed below.

### 5.1. Surface Preparation

The surface preparation process can vary depending on substrate material, adhesive used, and test application. For most applications, some abrasion of the surface will be required to provide bonding zones for the adhesive. Grit blasting is a common alternative to sanding metal surfaces. For rough surfaces such as concrete or composites, a layer of adhesive can first be cured onto the surface, before sanding this layer and applying the fiber to the surface. Other than cleaning the surface with isopropyl

alcohol post-abrasion, some adhesive suppliers recommend an acid etch and neutralizer that are typically included with other adhesive types.

## 5.2. Adhesive Selection

For long term, high strain, or harsh environmental applications, typically two-part epoxies are used. Luna has past experience with M-Bond AE-10, M-Bond GA-2, M-Bond 600 and M-Bond 610. M-Bond AE-10 is a two-part epoxy which is highly resistant to moisture and most chemicals, and results in a hard, water-resistant coating. Adhesive manufacturers provide technical documentation that helps guide users on optimal adhesive selection for their application [4].

## 5.3. Adhesive Application

The use of two-part epoxies requires careful planning as they typically have a short pot life. Pot life can be extended by spreading the epoxy into a thin layer on a clean Aluminum plate after mixing is complete. Additionally, other applicators can be used to dispense the adhesive, such as paint brushes, wide foam brushes, and silicone squeegees.

## 6. References

1. M-Bond 200 data sheet: <http://www.vishaypg.com/docs/11010/bond200.pdf>
2. M-Bond 200 MSDS:  
[http://www.vishaypg.com/docs/14027/14027Z\\_M\\_Bond\\_200\\_Adhesive\\_SDS\\_US\\_V2.pdf](http://www.vishaypg.com/docs/14027/14027Z_M_Bond_200_Adhesive_SDS_US_V2.pdf)
3. Skontorp, A, Levin, K, Benmoussa, M. Surface-mounted optical strain sensors for structural health monitoring of composite structures. Sixteenth Technical Conference of the American Society for Composites. Blacksburg, VA; USA. 9-12 Sept. 2001. 12 pp.
4. <http://www.vishaypg.com/micro-measurements/installation-accessories/adhesives/>



## 7. Product Support Contact Information

<b>Headquarters:</b>	3155 State Street Blacksburg, VA 24060
<b>Main Phone:</b>	1.540.961.5190
<b>Toll-Free Support:</b>	1.866.586.2682
<b>Fax:</b>	1.540.961.5191
<b>Email:</b>	<a href="mailto:solutions@lunainc.com">solutions@lunainc.com</a>
<b>Website:</b>	<a href="http://www.lunainc.com">www.lunainc.com</a>

Specifications of products discussed in this document are subject to change without notice. For the latest product specifications, visit Luna's website at [www.lunainc.com](http://www.lunainc.com).

© 2017 Luna Innovations Incorporated. All rights reserved.  
Technical Note EN-FY1701

