

F3D

Users Guide

Ver.3.3



Index

Introduction	5
1. 3Dviz Tool Overview	6
1.1. Launch software	6
1.2. 3Dviz GUI.....	6
1.3. Tabs area	7
1.4. Context menu.....	7
2. Fiber route configuration	8
2.1. Importing 3D Model and Image.....	8
2.1.1. Importing image	8
2.1.2. Importing 3D Model.....	8
2.1.3. View operations in Model View Area.....	8
2.2. Drawing fiber route.....	9
2.3. Fiber Location and Channel Number Settings.....	11
2.4. Saving and loading fiber routes	12
2.4.1. Preserving fiber routes	12
2.4.2. Loading Fiber Routes	12
3. Drawing setting	13
3.1. Changing view settings of 3D Model (Tria Setting)	13
3.2. Changing Contour Colors (Contour Setting).....	15
3.3. Saving and Importing Drawing Conditions (View)	15
3.4. Configuring 2D Graphs (Chart Setting)	16
4. Real-time 3D visualization.....	17
4.1. Connect the PC to the LAN.....	17
4.2. Set the IP address.....	18
4.2.1. Setting IP address of ODiSI Controller	18
4.2.2. Set the communication of the ODiSI controllers.....	20
4.2.3. Configure the F3D software	20
4.3. Real-time visualization screen	21

5.	Visualize measurement result files in 3D	22
5.1.	Reading measurement data (Playback Setting)	22
5.2.	Play Measurement Data	23
5.3.	Exporting Movies and Images	24
6.	Filter Tools	26
6.1.	Overview	26
6.2.	Launch Filter Tool	26
6.3.	Input/output of measurement result file	27
6.3.1.	Reading the Measurement Result File Including NAN	28
6.3.2.	File information	30
6.3.3.	About	31
6.4.	Operating 3D Graph	32
6.4.1.	Changing view position	32
6.5.	View setting	33
6.5.1.	Changing the Graph Scale	33
6.5.2.	Selection of the drawing area	34
6.5.3.	Contour Range	35
6.5.4.	Axis Label Setting	36
6.5.4.1.	Changing Scale of Axis Labels	36
6.5.4.2.	Example of the procedure for changing the axis label (X axis)	37
6.5.4.3.	Example of procedures for changing axis labels	38
	(Change intersection of axes)	38
6.5.4.4.	Example of the procedure for changing the axis label (Changing axis label name)	40
6.5.4.5.	Example of the procedure for changing the axis label	41
	(Changing scale interval)	41
6.5.5.	Cross-Section display	42
6.5.5.1.	Procedure for displaying cross sections	42
6.5.5.2.	Cross-sectional graph	46
6.6.	Adding points	50
6.6.1.	Point selection	50
6.6.2.	Point selection menu	50

6.6.3.	Distance between two points	51
6.7.	Filter function	52
6.7.1.	Viewing the Filter Dialog	53
6.7.2.	Cut-off filter	54
6.7.2.1.	Cut-off Filter Settings	54
6.7.3.	Median filter.....	55
6.7.3.1.	Median Filter Settings.....	55
6.7.4.	Short Wavelength Cut Filter	56
6.7.4.1.	Configuring Short Wavelength Cut Filters	56
6.7.5.	Change cutoff filter	57
6.7.5.1.	Change Cutoff Filter Settings.....	57
6.7.6.	Saving Filter Data	58
6.7.6.1.	Procedure for saving filter data	58
7.	Temperature Conversion Tool.....	59
7.1.	Launch Temperature Conversion Tool.....	59
7.2.	Select input data	60
7.3.	Select output destination.....	60
7.4.	Select Fiber Type.....	60
7.5.	Enter Reference Temperature	61
7.6.	Run Conversion Process	61
	Software update log	62

Introduction

The F3D measurement data processing software is software for filtering and visualizing measurement results outputted from the ODiSI.

The F3D software consists of a 3Dviz tool for 3D visualization and a filter tool for filtering.

There are two main ways to visualize data from ODiSI control software. The first method is to visualize the 3D in real time. The first method is to sequentially view the measurement results that are streamed. The second method is to use the measurement result file (tsv file) outputted in the ODiSI controllers after the measurement is completed.

The flow of each method is as follows.

[Real-time visualization]



[3D Visualization using recorded file]

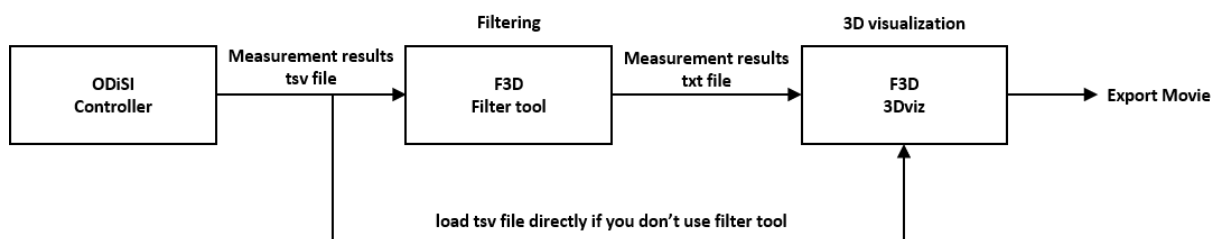

1. 3Dviz Tool Overview

The 3-D visualization tool "F3D 3Dviz" is a software that allows real-time visualization of measurement data and animation creation from visualization of historical measurement data using photographs or 3D models of measurement objects. Since the measurement data at multiple points can be visualized at once, it is possible to easily grasp the phenomenon and the measurement state.

1.1. Launch software

Double-click the 3Dviz icon  or select 3Dviz from the Windows Start menu.

For information about installing software and activating licenses, please read F3D Installation Guide.

1.2. 3Dviz GUI

F3D 3Dviz GUI is classified into three area.

Model view area	Main area in which the visualization results are displayed. Right-click in the area to display context menu.
Tabs area	Upper-left corner. Including Contour tab and Routing tab.
2D graph area	Lower-left corner. 2D graph of that time is displayed.

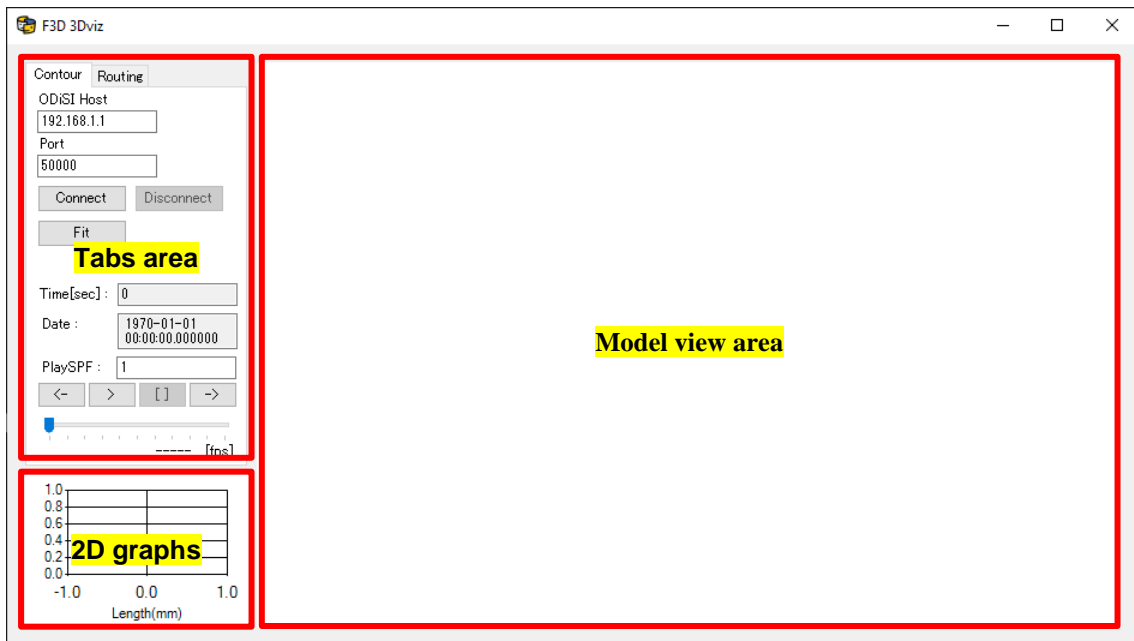

F3D 3Dviz GUI

1.3. Tabs area

There are two tabs in the Tabs Area: "Contour" and "Routing" tabs, and you can switch between tabs depending on the task. For details on how to operate each tab, please refer to the briefing of the corresponding operation.

Contour tabs

Configuring connections with ODiSI controller for real-time visualization, Playback control can be performed when reading the measurement result file.

Routing tabs

You can configure fiber routes after switching to the Routing tabs.

The table in the Tabs Area shows the channel number of the selected fiber route and the fiber position of each node, which can also be edited.

1.4. Context menu

Right-click in Model View Area to display the context menu and perform various operations. For instructions on how to use each menu, please refer to the instructions for each operation.

Image...	Imports an image of an object to be measured
Stl...	Import STL 3D model of the object to be measured.
FiberLocation...	Save and load fiber location information
View...	Save and load view settings
TriaSetting...	Changes View settings of 3D model
ContourSetting...	Changes the color and range of the contour, the presence or absence of the contour, and the fiber display thickness.
PlaybackSetting...	Imports, sets, and outputs moving images of past measurement data
ViewSetting...	Changes the screen size of the model view area.
Launch FilterTool...	Launch FilterTool.
Launch SpectralShift to Temperature Tool	Launch application tool to convert spectral shift data to temperature data
About...	Show software version information

2. Fiber route configuration

This chapter describes how to load images and 3D models of the measurement object, set the fiber path, and set the fiber position.

2.1. Importing 3D Model and Image

Loads an image or 3D STL model of the objects that you want to draw fiber routes.

2.1.1. Importing image

- (1) Right-click on model view area and select "Image"→"load".
- (2) Select and open the image you want to import. For the format of images that can be read .bmp, .png, .jpg, .jpeg, .tif, .tiff.

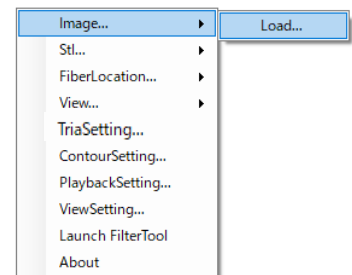

2.1.2. Importing 3D Model

- (1) Right-click the Model View area and select "Stl"→"load".
- (2) Select and open the STL file that you want to import.

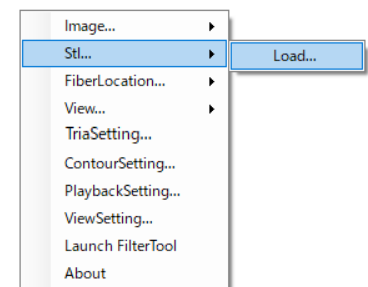

2.1.3. View operations in Model View Area

Left drag	Model rotation
Right drag	Model translation
Wheel scrolling	Zoom-in/ Zoom-out
Middle click	Set the Rotation Center
Right-click	Open context menu

2.2. Drawing fiber route

This section describes how to draw fiber routes on 3D model.







You can also draw fiber routes on images in the same way.





The fiber route is drawn by first creating a point on the fiber route and then connecting the created points by a line segment, as shown in the procedure below.

- (1) Switch the Tabs Area to the Routing tab
- (2) "Ctrl + left-click" to generate a point (first point generation)
 - ※ If the point is hard to see, resize the point by referring to Changing the Contour Color (Contour Setting).
- (3) Generate a second point in the same way as in (2).
- (4) "Ctrl + left click" a generated green point to make it yellow selected status (1st point selection).
- (5) "Ctrl + left-click" the other green point (select the 2nd point, create a line segment)

How to create, edit, and delete points and line segments is as follows.

List of operations when creating fiber routes

When nothing is selected			
Operation	Target	Behavior	Changes in the screen
Ctrl + left-click	STL	Generate point	
	Line	Insert point	
	Point	Select point	
Ctrl + right-click	STL	-	
	Line	Delete line	
	Point	Delete point	
When a point is selected			
Ctrl + left-click	STL	Move point	
	Line	Insert Point	

	Point	Generate line	
Ctrl + right-click	STL	Deselect	
	Line	Deselect	
	Point	Deselect	

For fiber routes, please draw only the route used as the measurement area(sensor). You do not need to draw routes which is not for measurement.

For example, a single fiber line as shown below→Takeover→If the fiber is stretched like a straight line, only the straight-line section is drawn.

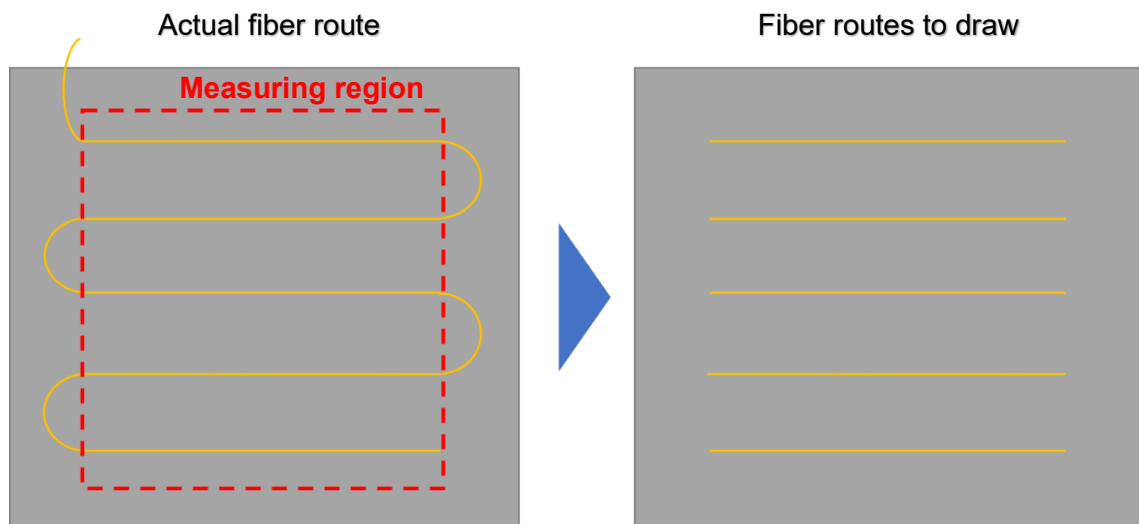

2.3. Fiber Location and Channel Number Settings

After drawing a fiber route, assign a channel number to each fiber route and register fiber position information for each point (how many m positions each point is in the fiber).

To set the fiber route, select the fiber route → enter the channel number → enter fiber position information for each point.

- (1) Switch to Routing Tab.
- (2) Select a green point on the fiber route by Ctrl and left-clicking.

When Fiber Route is selected, Tabs Area displays the channel number of the selected Fiber Route and the location of each point.

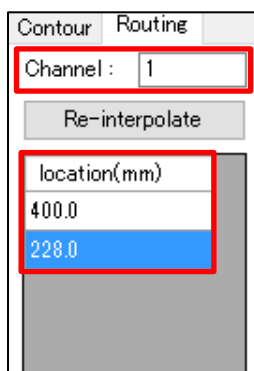

Channel: Fiber Root Channel Number
 Location(mm): Location of points
 0 is the default value before input.

A blue highlighted row in the list indicates that the point is selected and corresponds to the yellow point in Model View Area. If you select a different row (different point) on the list, the corresponding yellow point is selected in Model View Area.

- (3) Enter channel number of the route in the Channel field.
 When you enter a channel number, the Fiber route changes its display color according to the channel number.
- (4) Enter the location of each point you saved when preparing for measurement. If there is a point whose location information is unknown, please enter only the location information of the start and end points of the fiber route.
- (5) (Only when location information is unknown)
 Clicking Re-interpolate automatically interpolates the location(mm) of each point according to the location of the start point and the end point and the fiber route length on the model.

2.4. Saving and loading fiber routes

Drawn fiber routes and fiber route settings can be saved to a file and reused.

2.4.1. Preserving fiber routes

- (1) Right-click in Model View Area and select FiberLocation→Save.
- (2) Specify the destination and file name to complete the save.

2.4.2. Loading Fiber Routes

- (1) Right-click in Model View Area and select FiberLocation→ Load.
- (2) Select the fiber location file (.fld) to load.

3. Drawing setting

This section describes how to change the drawing settings for each area.

3.1. Changing view settings of 3D Model (Tria Setting)

To open tria view configuration, please right-click in Model View Area and select TriaSetting from the menus.

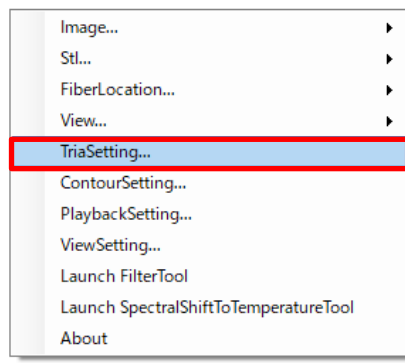

Changing Color of 3D models

To change surface color of the 3D model, click the color box next in the Tria area and select a color from the color palette.

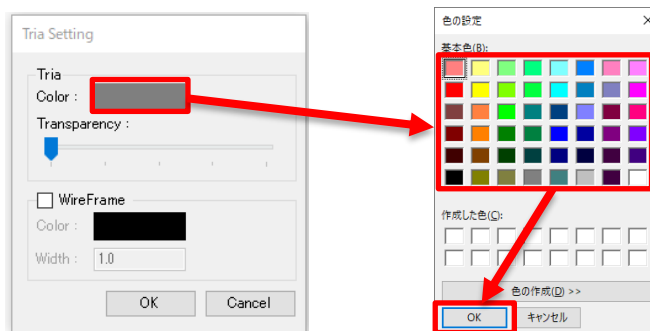

Changing Transparency of surface

Transparency of 3D model can be changed with Transparency bar in Tria area

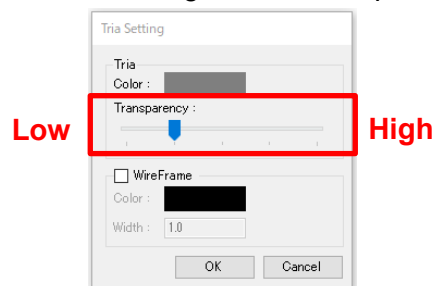

Show / Hide Wireframe of 3D models

Fill in a check box to show wireframes of 3D models.

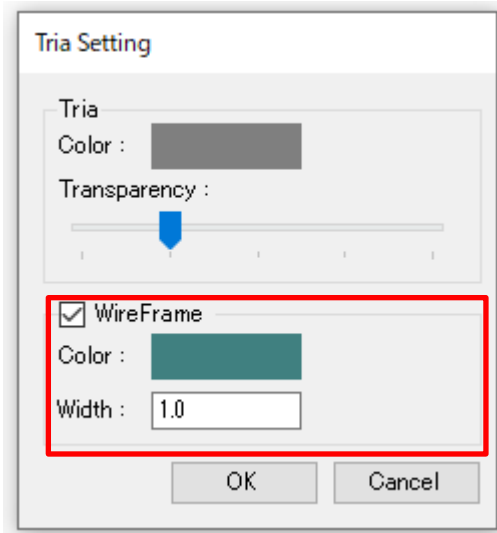

To change colors of wireframes, please click color box in WireFrame area and select a color from color palette.

Enter an arbitrary value for the thickness of the wireframe in the text box next to Width: .

3.2. Changing Contour Colors (Contour Setting)

(1) Right-click in Model View Area and select TriaColorSetting from the menus.

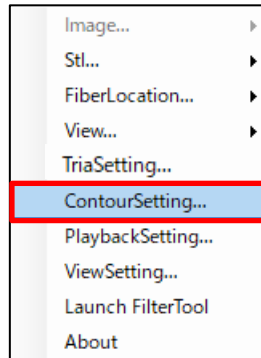

(2) Enter each parameter, select it, and click OK.

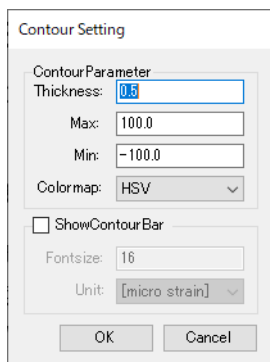

Contour Parameter	
Thickness	Fiber Route Point and Line Segment Thickness (Size)
Max	Maximum value of the contour
Min	Minimum value of the contour
Colormap	Type of color scheme for the contour bar Select from [HSV] [JET] [COOL] [HOT].
ShowContourBar	Displayed On/Off of the contour bar
FontSize	Contour Bar font size
Unit	Unit to be displayed in the converger [micro strain] [deg C] [GHz]

3.3. Saving and Importing Drawing Conditions (View)

Save Drawing Conditions

- (1) Right-click in Model View area and select View→Save from the menus.
- (2) Specify and save the destination and file name.

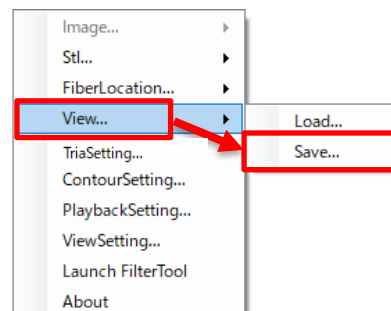

Importing Drawing Conditions

- (1) Right-click in Model View area and select View→Load from the menus.
- (2) Specify and read the drawing condition file (.fwv file) to be read.

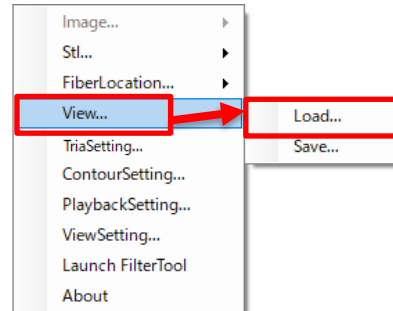

3.4. Configuring 2D Graphs (Chart Setting)

You can set the minimum and maximum values for the horizontal and vertical axes for 2D graph area.

- (1) Right-click in the 2D graph area and select ChartSetting.
- (2) Enter maximum and minimum values for each axis and click OK.
Click the Fit button to fit the currently loaded data.

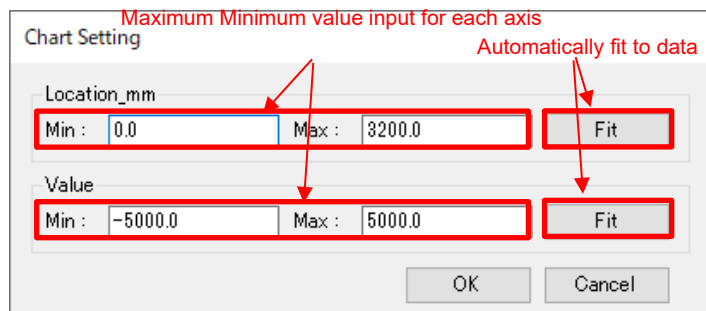
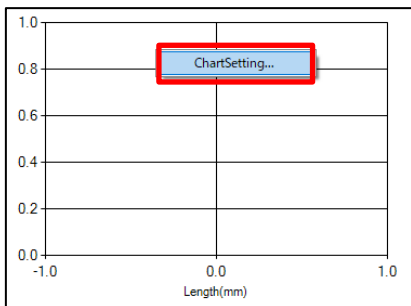

4. Real-time 3D visualization

With F3D 3Dviz tools, you can 3D visualize measurement data streamed from the controller in real time by connecting the F3D installed post-processing PC and the ODiSI controller PC by TCP/IP.

This section describes how to set up connections with ODiSI controllers after you have set up fiber routes and drawing conditions, and the drawing screens after the connections.

4.1. Connect the PC to the LAN

There are two methods of connecting the post-processing PC and the measurement control PC to the LAN: direct cable connection and connection to the same network.

(1) Connect directly to the LAN cable

Connect the post-processing PC and the measurement control PC directly with a LAN cable. This connection method is recommended because of the ease and the stability of the connection.

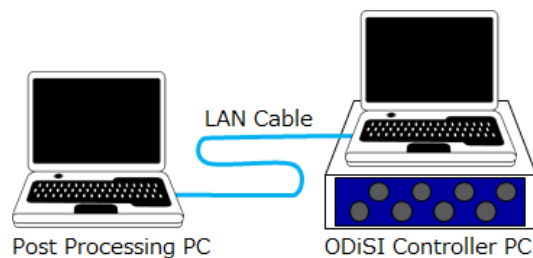

(2) Connecting Two PCs to the Same Network

When the ODiSI controller PC and the post-processing PC are located at different location or difficult connect them directly, you can establish connection by connecting the two PCs to the same network.

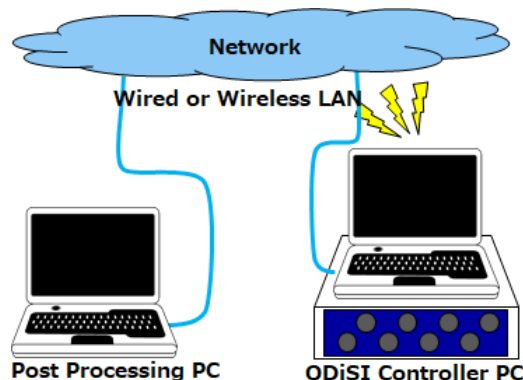

4.2. Set the IP address

Set the IP address (IPv4) of each PC.

To connect two PCs directly with a LAN cable, use the same value up to the third digit of the IP address and assign another number to the fourth digit.

IP Example of Address Setting

	ODiSI Controller PC	Post-processing PC
IP address	192.168.1.1	192.168.1.2
Subnet mask	24	255.255.255.0

When connecting via a network, set the connection according to the network you are using.

4.2.1. Setting IP address of ODiSI Controller

- (1) On the left-hand task bar, click System Setting.

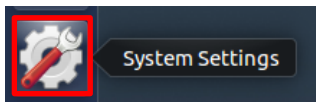

- (2) Open Networking Settings by clicking Network Icons

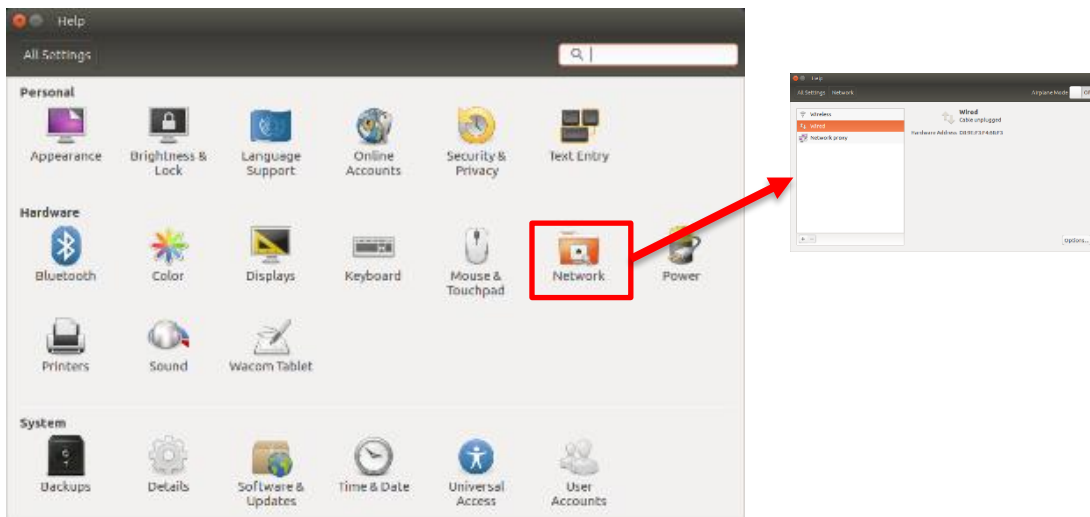

- (3) Select "Wired" from the left-hand list.
"Wired" is not displayed unless a LAN adapter is connected to the PC.
- (4) Turn on the upper-right Wired button
- (5) Click the lower right Options to open Advanced Settings.

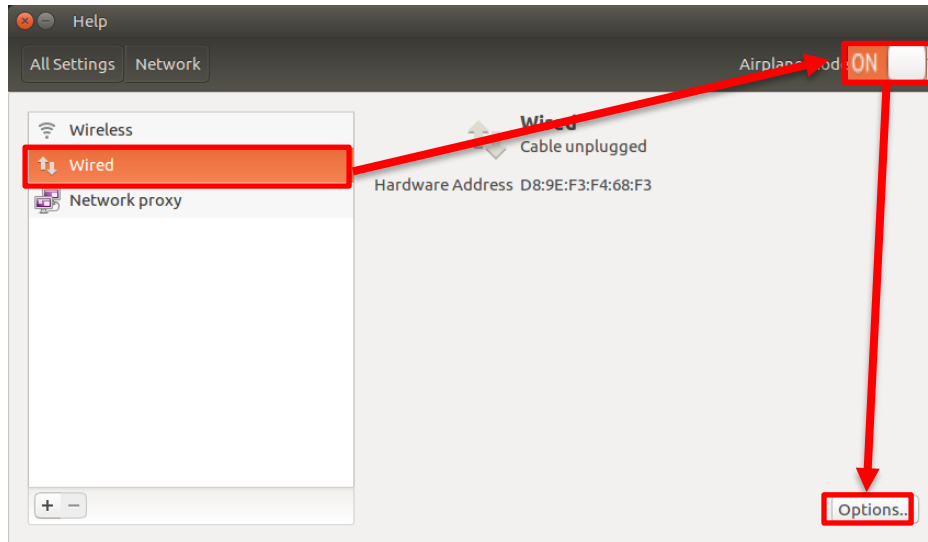

- (6) Select the IPv4 Setting tabs
- (7) Select "Manual" from the Method pull-down menu.
- (8) Click the Add button
- (9) Enter "24" in the "192.168.1.1" Netmask in the Address.
- (10) Clicking Save to complete the settings

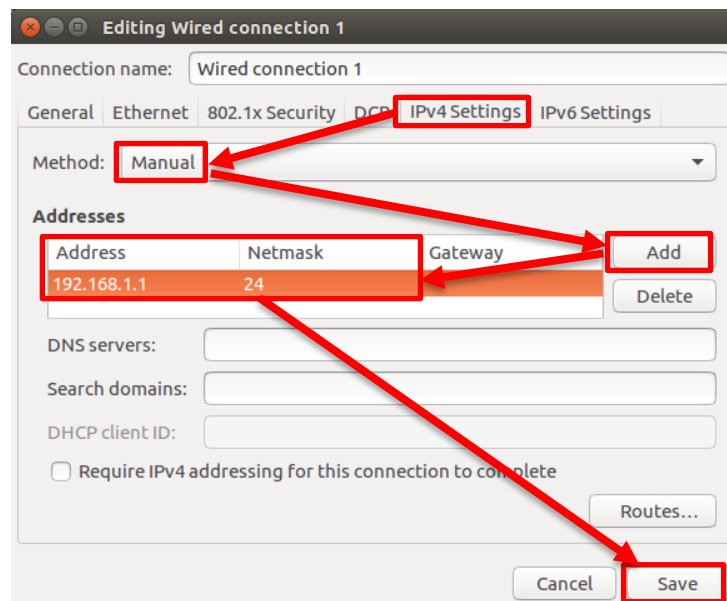

4.2.2. Set the communication of the ODiSI controllers.

Use “Streaming Properties” to stream externally on ODiSI controller.

This section explains how to easily set streaming properties. Check the ODiSI 6100 User Guide for more information about the properties menu.

- (1) Open “Streaming Properties” tab.
- (2) Check the “OMSP Enable” to enable external streaming.
(OMSP= ODiSI Measurement Streaming Protocol)
- (3) Check the IP address and port number.
Required for F3D connection setup.

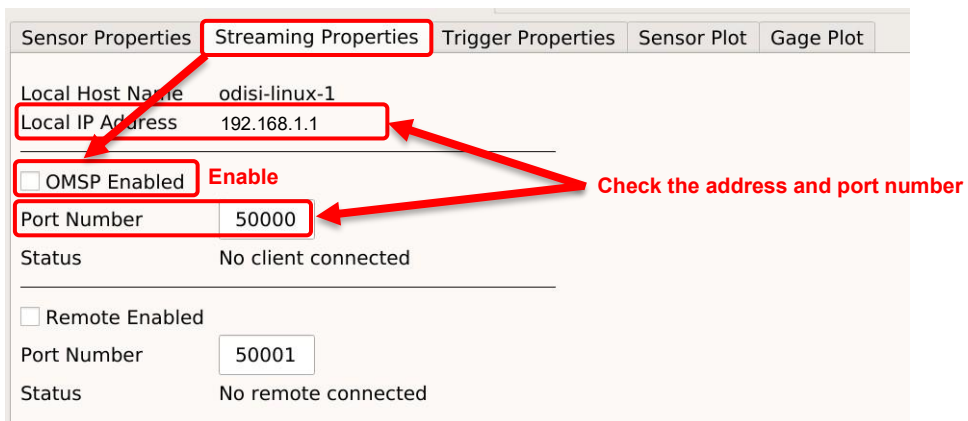

4.2.3. Configure the F3D software

Complete the network settings for the post-processing PC.

- (1) Enter the IP address of ODiSI controller PC (IP checked above)
- (2) In the same way, enter the destination port number in the Port.
- (3) Connect by clicking the Connect.

If the connection fails, make sure that streaming is enabled on the ODiSI controllers, that the measurement is started, and that there are no problems with the network connection.

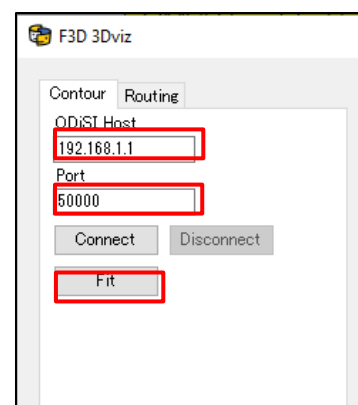

4.3. Real-time visualization screen

When the measurement data is streaming from the ODiSI controllers after the connections are established, the display is automatically updated according to the measurement data.

- Measured values are represented by color contours on the drawn fiber.
- You can freely change the view even during real-time visualization.
- Adjust the upper and lower limits of the contour, check the presence or absence of a contour, and check the thickness of the fibers from the right-click menu ContourSetting.
- The 2D graph area displays the measured data of the channels with the horizontal axis as the distance in real time.
- Click Disconnect to stop updating screen.

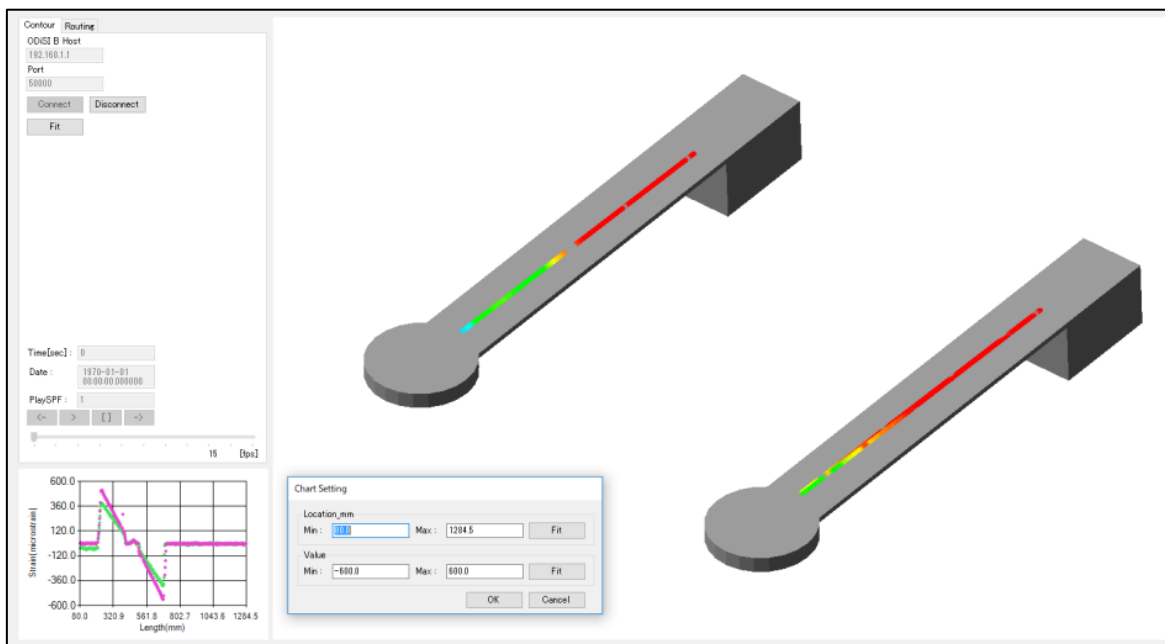

5. Visualize measurement result files in 3D

Using the playback function, you can read past measurement data, visualize it, and export a moving, images.

5.1. Reading measurement data (Playback Setting)

Measurement data format that can be read is the .tsv file ex by the ODiSI controller or the txt file output by Filter Tool. Use full.tsv for tsv files. You cannot use gages.tsv.

Specify the measurement data using the PlaybackSetting that can be opened from the right-click menu.

Playback Setting window

Click for each channel to select measurement data

Unload read data

When you click Pull, a value automatically input to fit measurement data.

PlaybackFiles	Selection of measurement data (full.tsv, .txt) to be referenced
BaseDate	Setting Movie Reference Time
TimeBegin	Setting movie start time
TimeEnd	Setting Movie End Time
TimeInterval	Setting the frame advance time interval
IntervalNum	View Frame Count (automatically set by TimeInterval)

5.2. Play Measurement Data

The read measurement data can be played back in the Contour tab area.

You can also control frames by using the play control buttons or by dragging the seek bar.

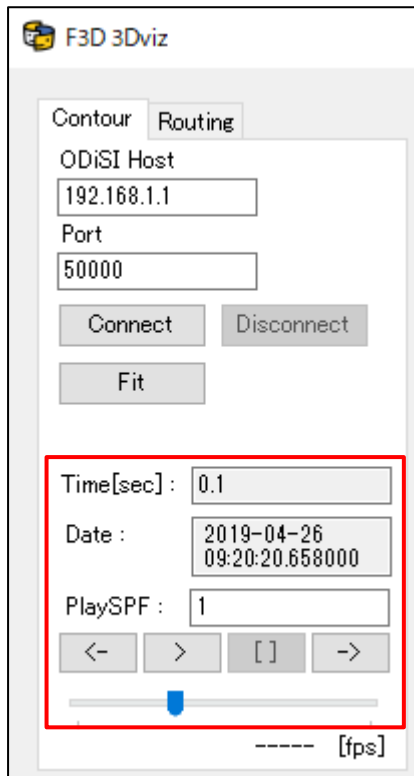

Time[sec]	Displaying Playback Time
Date	Display of the reference time
PlaySPF	Seconds Per 1 Frame
>	Playback start button
[]	Stop button
< -	Back frame button
- >	Forward frame button

5.3. Exporting Movies and Images

You can export movies and images in the Playback Setting window

- (1) Click ExportMovie button at the bottom left of the Playback Setting window.

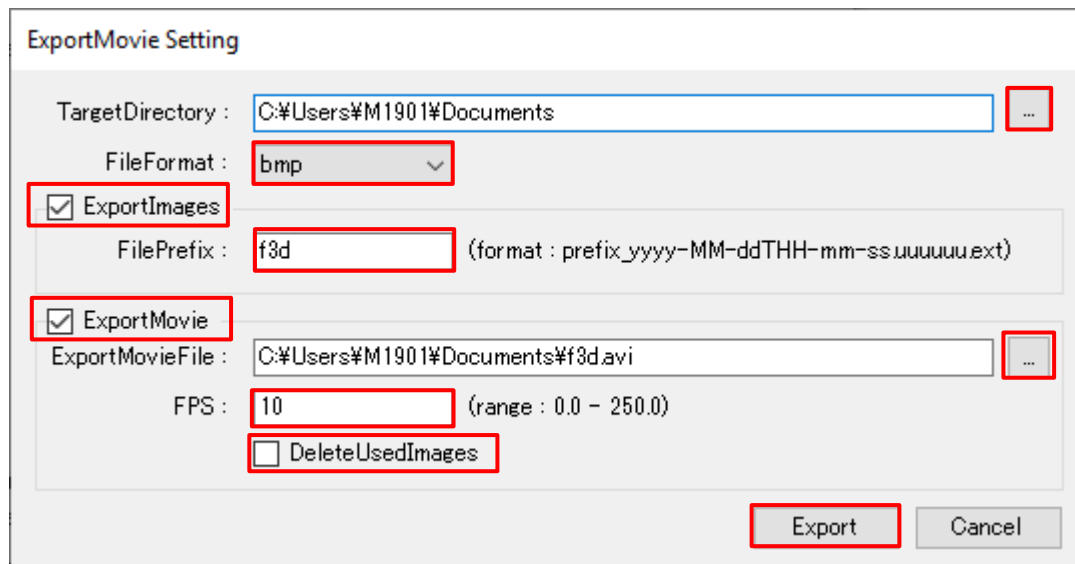
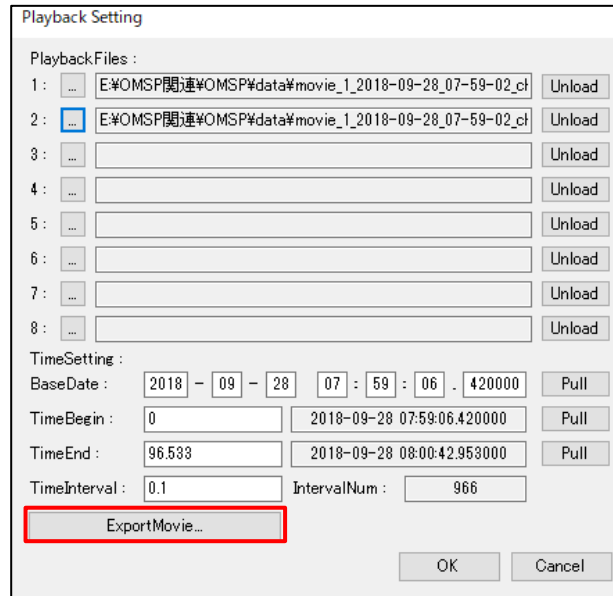

- (2) Specify location for exporting in TargetDirectory.
- (3) Select a format of Images in the FileFormat pull down menu
- (4) To export images of individual frames, check the "ExportImages" check box and enter a prefix in "FilePrefix".

- (5) Check "ExportMovie" to export a movie.
- (6) Specify the location for exporting and filename of movie in the ExportMovieFile.
- (7) Specify the FPS of the movie to export (0 to 250, usually less than 30)
- (8) To delete an image used when generating a movie, check "DeleteUsedImages".
- (9) Click Export to open Videos Compression Settings window.

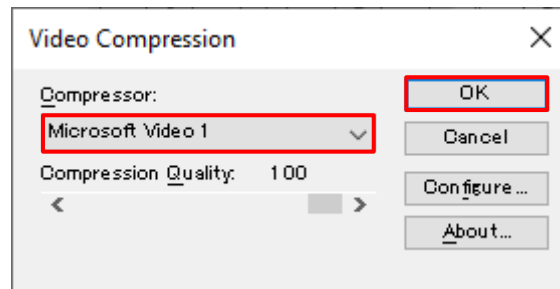

- (10) Select a compressor (typically using Microsoft Video 1)
- (11) Click OK to start the export.

6. Filter Tools

6.1. Overview

The F3D filtering tool is an application tool for eliminating noise during measurement and dividing and extracting measurement data by graphing the Strain quantities and temperature distributions of measurement data in three dimensions.

By filtering the noise processing while checking the data on the three-dimensional graph, you can easily understand whether the noise processing is performed properly. It is also possible to analyze in more detail by displaying a two-dimensional graph or measuring dimensions at an arbitrary position.

6.2. Launch Filter Tool

Right-click in the F3D 3Dviz Model View area and click Launch Filter Tool to launch the filter tool.

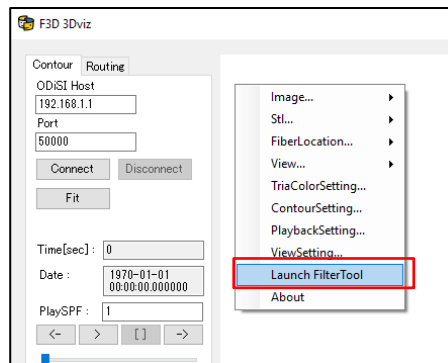

The filter tool consists of four display areas: the 3D Area, the 2D Area, the Filter Area, and the Graph Control Area.

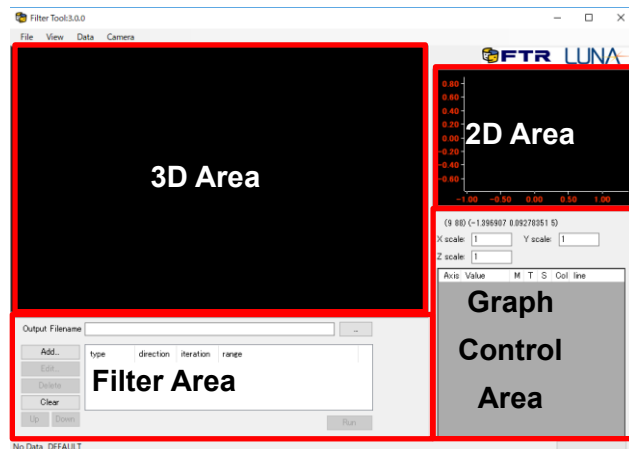

6.3. Input/output of measurement result file

From the File menu, you can check the file information. Select [File] to open the following menu bar.

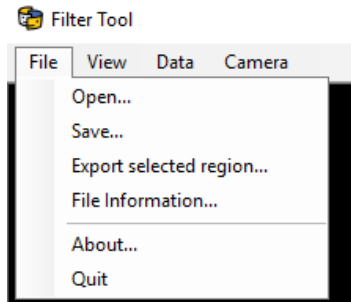

[Open] : Open the text (.txt), CSV, and.tsv files of measurement data.

[Save] : Save the filtered data in text (.txt) or CSV (.csv) format.

[Export selected region] : Outputs data within the range selected in the 2D Area.

[File information] : Show the information of the read measurement data.

[About] : Show the About window and display the versions of the filter tool software.

[Quit] : Exit the filter tool software.

6.3.1. Reading the Measurement Result File Including NAN

By ODiSI-6100, the measured values for low-quality Fibre Sensors are Output with the string [NAN] embedded.

The F3D filtering tool cannot read data including NANs directly, and an error message as shown below appears.

To read a file, you must convert it once to a file that does not contain NANs, and then reload the converted file.

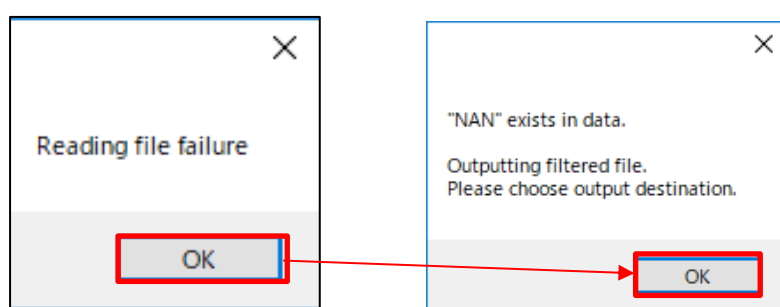

When you click OK , the window for converting the file as a.txt file opens. Enter an arbitrary name and save it.

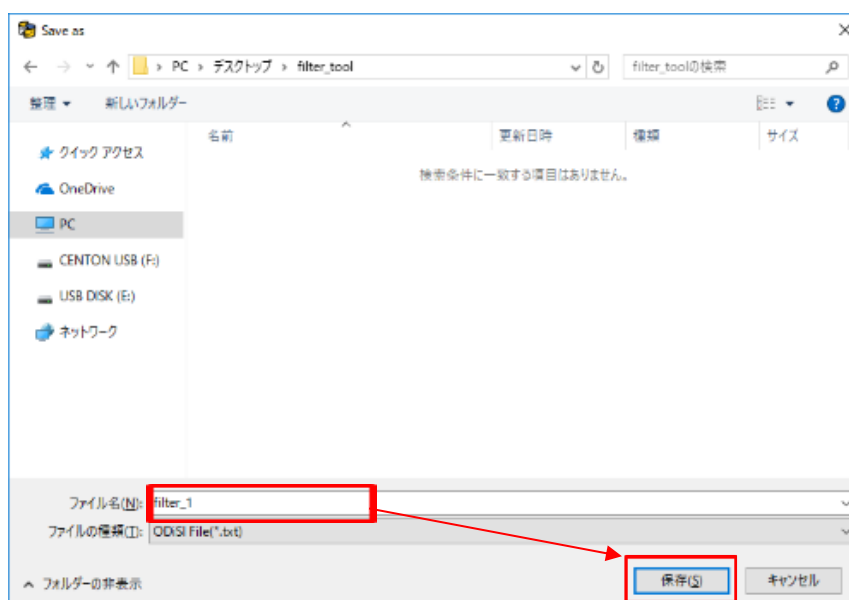

Click Save to open the window for data conversion, and you can select two

conversion methods.

Interpolate [NAN] from previous and next data

Linear interpolation is performed from the previous or next time or gage value.

Select [Time][Length] for linear interpolation and click OK to save the interpolated data.

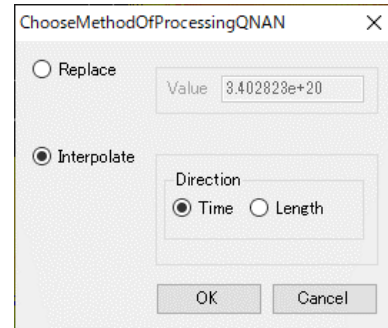

Replace [NAN] with a fixed value

Replaces all NANs with the user-specified value and reads it.

After entering the replacement value, click OK to save the data with NAN replaced by the fixed value.

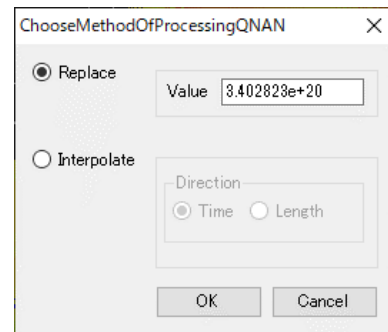

After saving the interpolated/replaced data, select [File] on the menu bar and press [Open] to load the saved data.

6.3.2. File information

Shows information of the opened measurement data.

The unit is displayed in the opened text file (.txt). In the following example, the length unit is [m] and the time unit is [sec].

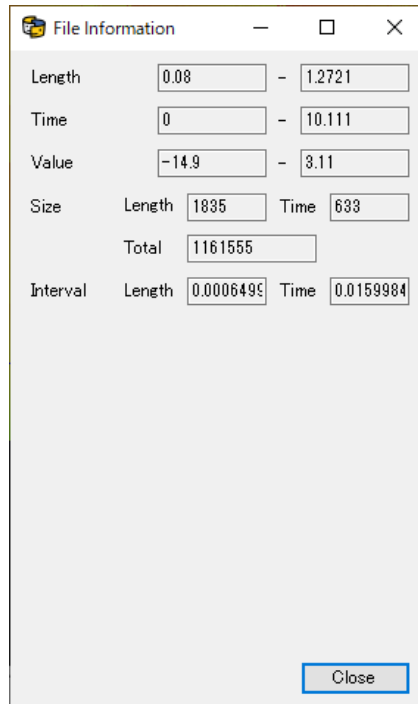

- Length : Minimum/Maximum Fiber Length Output Range
- Time : Minimum value and maximum value of measured time
- Value :Minimum value and maximum value of Strain/temperature/shift amount of measured data
- Size :Number of samplings in the lengthwise and temporal directions of the measurement data and the total.
- Interval :Length sampling interval [m] and time sampling interval [sec] of measurement data

6.3.3. About

[About] window shows you the version of the filter tool software.

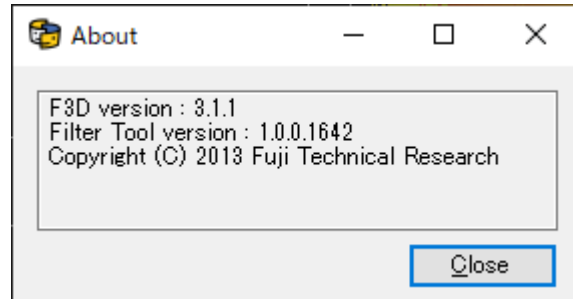

6.4. Operating 3D Graph

6.4.1. Changing view position

When the measured data is read in, the data measured by the ODiSI is displayed as a three-dimensional graph in the [3D Area]. The color is a contour according to the measured value. By default, the value closer to the maximum value is displayed in red, and the value closer to the minimum value is displayed in blue.

Mouse operation

Operation	Behavior
Ctrl + left-click	Point selection
Ctrl + left-drag	Rotating a 3D Graph
Ctrl + right-drag	Translation of a 3D graph
Ctrl + Wheels	Scaling 3D Graphs
"F" key	Screen fit
Left-click	Select a point in the vicinity.

Translation and scaling operation are same in 2D area.

6.5. View setting

The view setting is used to set how to draw a three-dimensional graph. You can specify the range of the three-dimensional graph, adjust the contour range and size, and display the cross-section graph displayed in the Filter Tool Control window.

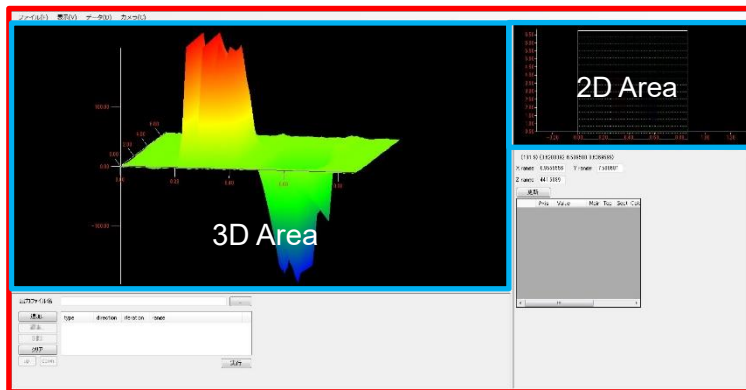

Analysis tool control window

- 3D Area : Displays three-dimensional graph of the measurement data
- 2D Area : Displays the top view of the three-dimensional graph in two dimensions.

6.5.1. Changing the Graph Scale

The scale for each direction changes in the graph control area. This value is entered directly and immediately applied. Scaling is used when the displayed length (X), measurement time (Y), or grandest value (Z) is not suitable for measurement data. By adjusting the scale, you can view the graph of the measurement data in more detail.

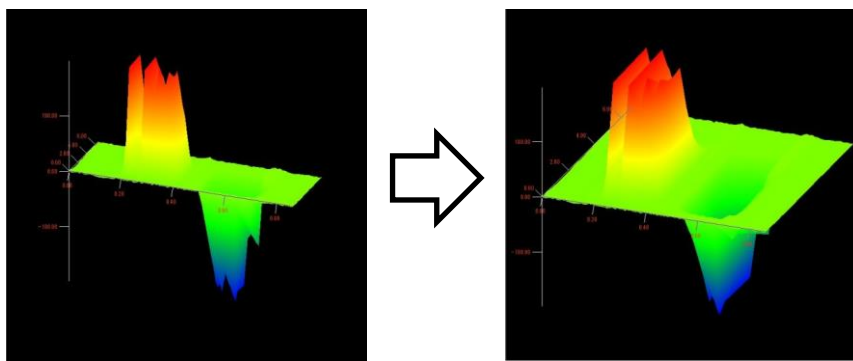

(19 2) (-0.1913297 167.1167 527.2943)

X scale: Y scale:

Z scale:

(47 1) (-0.01812476 168.0006 527.2943)

X scale: Y scale:

Z scale:

Note: X, Y, and Z are set to 1 by default.

If the measurement time is extremely short for fiber lengths and measurements and the graph contrast is not balanced, changing the time direction (Y) scale makes the graph easier to see.

6.5.2. Selection of the drawing area

Procedure for selecting a rectangular area

By selecting the area of the white rectangle displayed in the 2D Area, You can change the display range of the 3D Area.

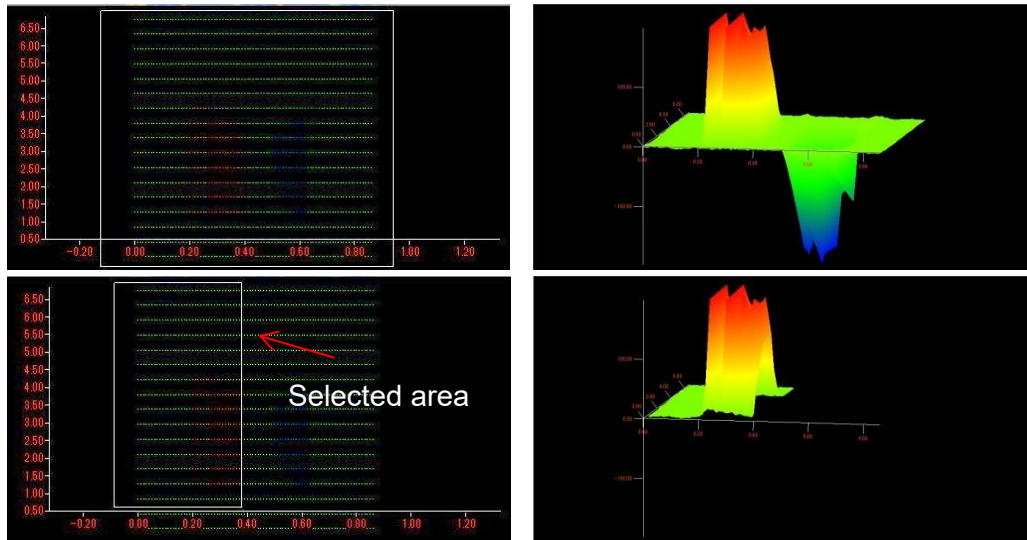

[left dragging] to select a rectangular area on the 2D area. A rectangle for selecting a range has been displayed since the 3D graph was opened, and the rectangle is used to select the range.

The graphs selected in the range can be output to a text file (.txt) or a CSV file (.csv) from [File] → [Export Selected Region] on the menu bar.

6.5.3. Contour Range

The contour of the 3D point cloud graph indicates the measurement value for each point.

By adjusting the contour range, you can color-code the displayed data graph in whole or in part to see the measurement value roughly or in detail.

Procedure for changing the contour range

Select [Contour range] from [View] on the menu bar to open [Contour Setting]

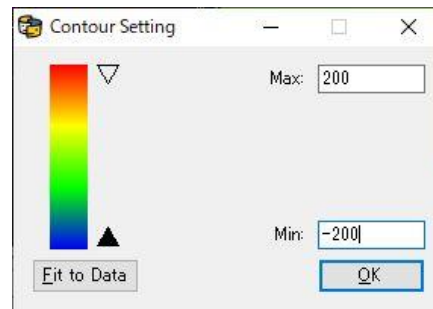
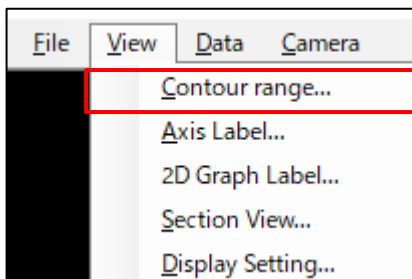

Select [Fit to Data] to automatically set the upper and lower limits to the maximum and minimum values of the measurement data.

Change the upper and lower limits if you want to set fixed value.

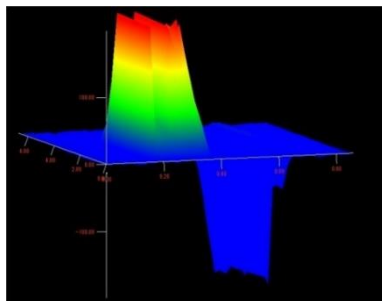

Three-dimensional

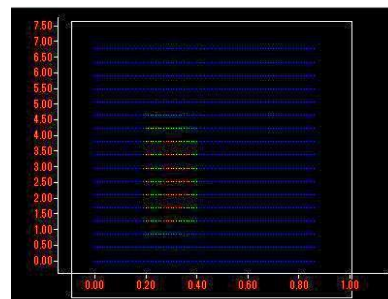

Two-dimensional

6.5.4. Axis Label Setting

Changes the axis labels (Axis Label) displayed in the 3D area.

6.5.4.1. Changing Scale of Axis Labels

Select [Axis Label] from [View] on the menu bar to open [Axis Setting] window.

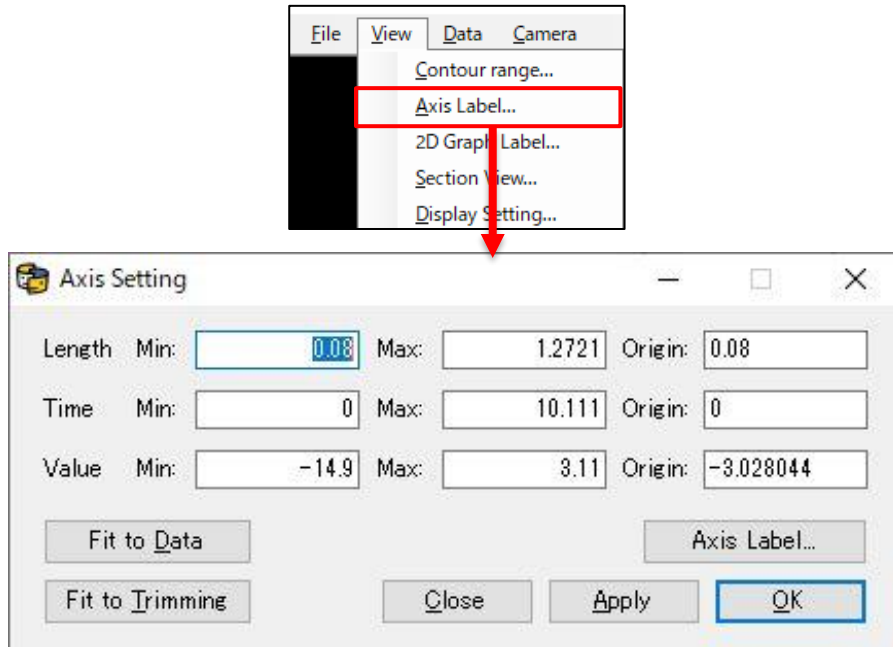

[Length] : Set X axis label (fiber length direction).

[Time] : Sets Y axis label (time direction).

[Value] : Sets Z axis label(Measurement value direction).

[min] : Sets the minimum value to be displayed on the axis label.

[max] : Sets the maximum value to be displayed on the axis label.

[Origin] : Sets the intersection position of the axis labels.

[tics] : Sets the scale interval displayed on the axis label.

[Fit to Data] : Fits the intersection of the axis labels to the measured data.

[Fit to Trimming] : Fits the intersection of the axis labels to the display area.

[Axis Label] : Set the axis label name and switch between display and non-display.

6.5.4.2. Example of the procedure for changing the axis label (X axis)

Changes the display range of the graph values on the X axis (length direction).

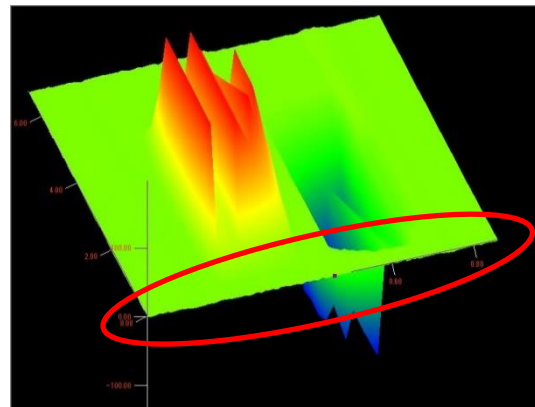
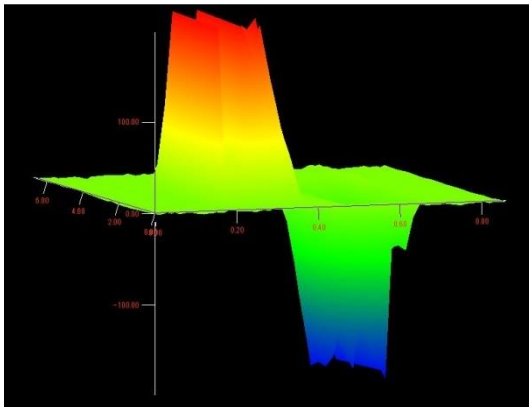
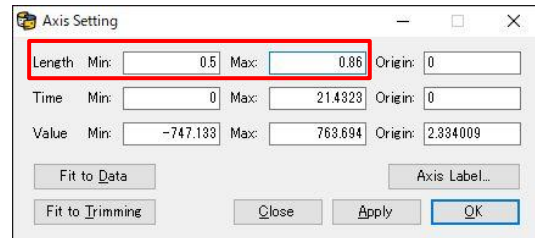
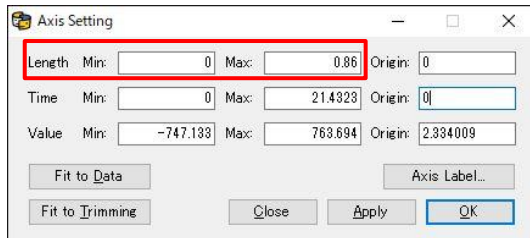

Changing the value of the length changes the display of the X-axis scale.

For [min], enter the minimum value of the axis label to be displayed.

For [max], enter the maximum value of the axis label to be displayed.

In the above figure, the initial value was [0 to 0.86], [min] is changed to [0.5] and the value of [0.5 to 0.86] is displayed, the scale of [0 to 0.49] is hidden. After setting the value, click [Apply] and [OK] to change 3D area.

You can also set [Time] and [Value] in the same way.

6.5.4.3. Example of procedures for changing axis labels (Change intersection of axes)

Manually Changing

Changes the display position of the axis label in the 3D Area.

By entering a number in the [Origin] of the [Length][Time][Value] in the [Axis Setting] window, the position where the axis labels are displayed can be moved up, down, left, and right.

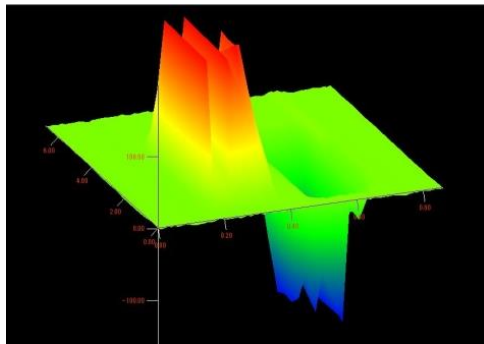
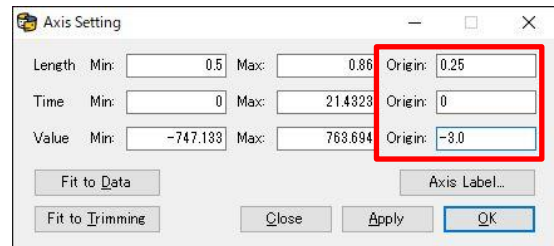
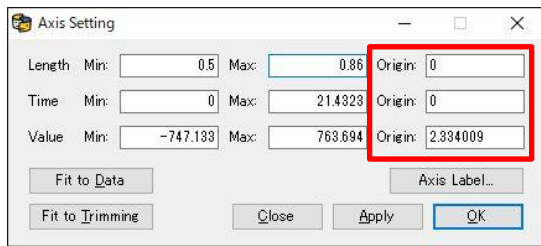

Before moving the axis label

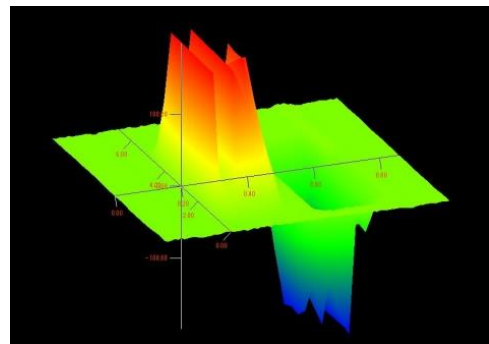
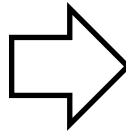

After moving the axis label

Fit to data Automatically

[Fit to Data] to move the axis labels to the appropriate position and show all range of data.

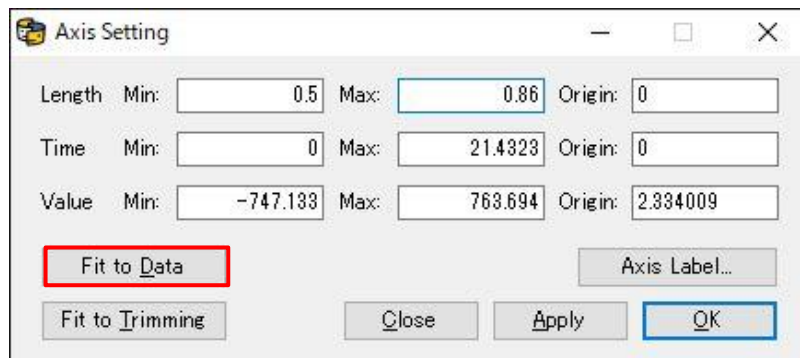

Fit to Trimming area

To fit the axis labels to the trimmed area, click [Fit to Trimming] button in the [Axis Setting] window. The axis labels that were fitted to the hidden part of the graph will fit to the displayed 3D graph.

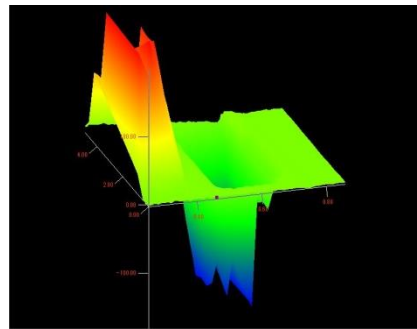
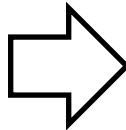
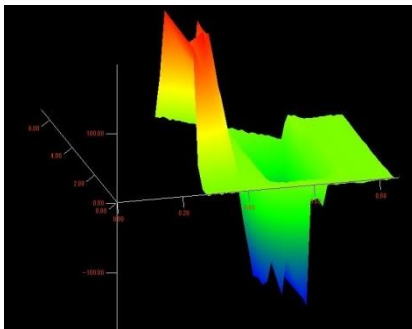
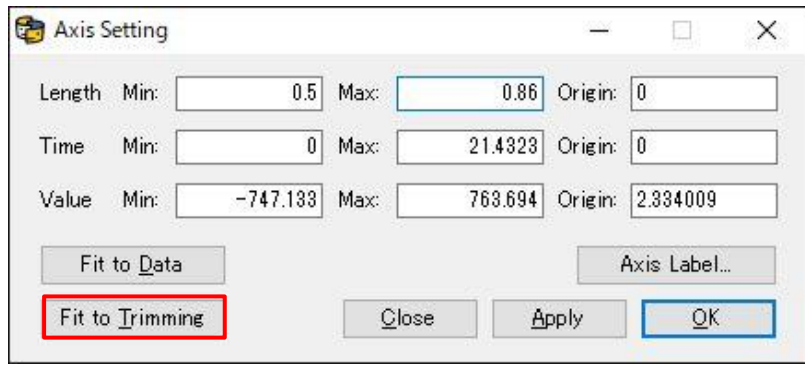

6.5.4.4. Example of the procedure for changing the axis label (Changing axis label name)

From the [Axis Setting] window, set the name of the axis label and whether the axis label is displayed or not.

You can open [Axis Label Setting] window by clicking [Axis Label] button in the [Axis Setting] window.

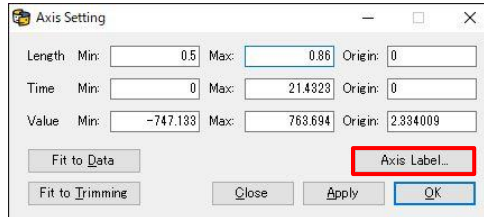

Checking [Visible] in the [Axis Label Setting] window displays the names of the axis labels in the 3D graph

When you enter a label name in [Axis Label], the name of the axis label is changed.

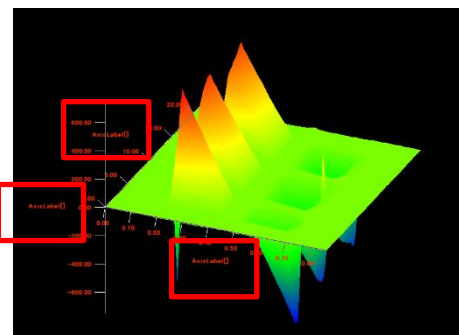
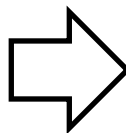
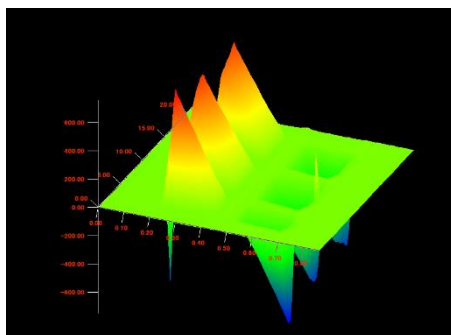
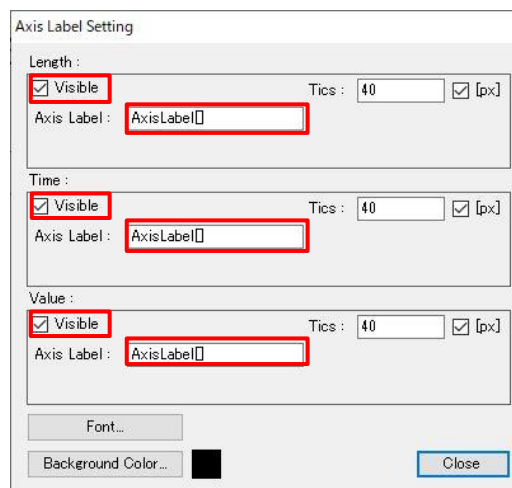

6.5.4.5. Example of the procedure for changing the axis label (Changing scale interval)

Set the axis label scale interval in the [Axis Setting] window.

Click the [Axis Label] button in the [Axis Setting] window to open the [Axis Label Setting] window.

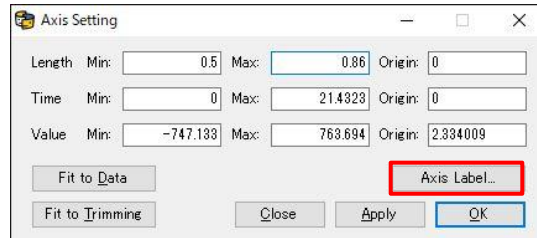

Enter the scale interval of the axis labels in [tics] of [Axis Label Setting].

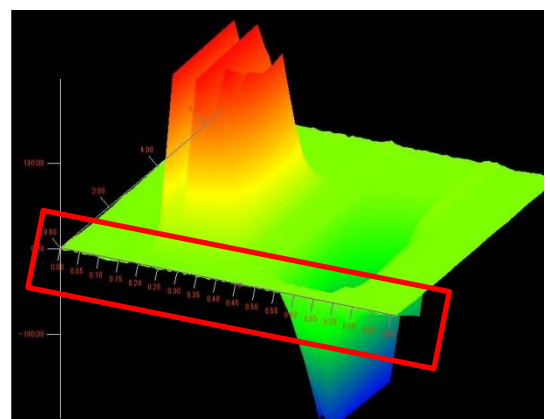
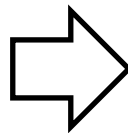
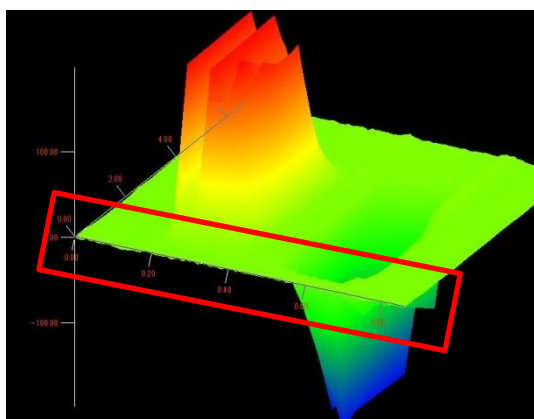
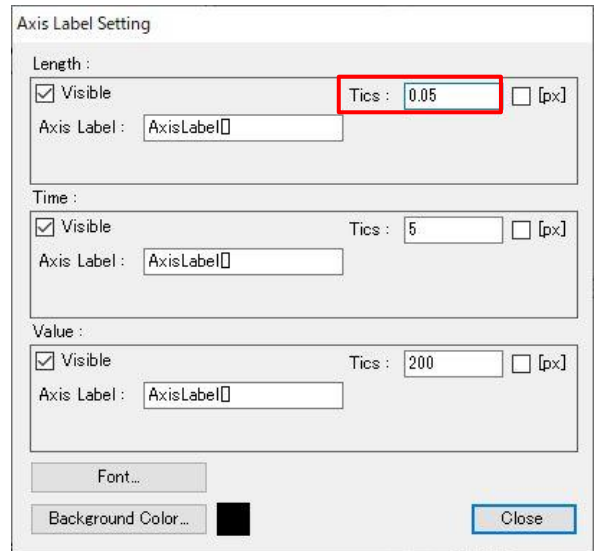
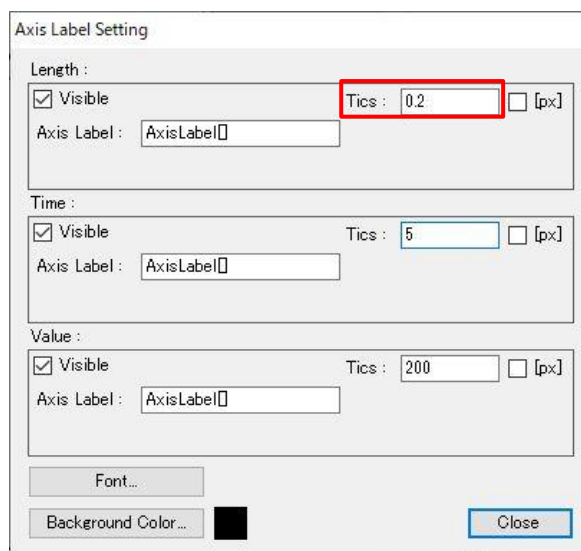

Although the default value of [tics] was displayed as 0.2, changing the value to 0.05 increases the scale in the length direction (X) and allows you to check the value in more detail. When [px] is checked, the [tics] values switch to pixel-by-pixel displays.

6.5.5. Cross-Section display

6.5.5.1. Procedure for displaying cross sections

Show Cross-section of the 3D graph

Right-click on graph to open context menu.

Select [Add X-Z Section] to view the cross section in the X-Z orientation.

Select [Add Y-Z Section] to view the cross section in the Y-Z orientation.

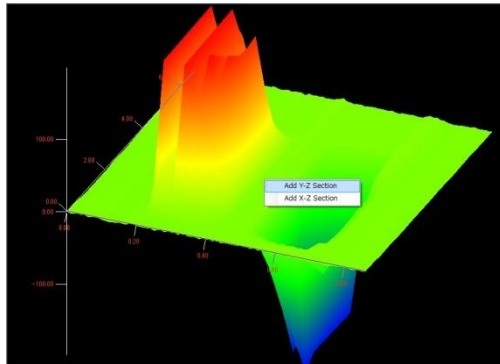

Display of cross section menu

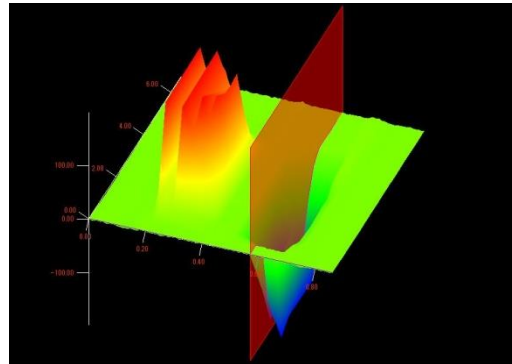

"Add Y-Z Section"

When you create cross section in 3D graph, the [Section View] Window opens at the same time. You can also open the [Section View] window from the [View]→[Section View] menu.

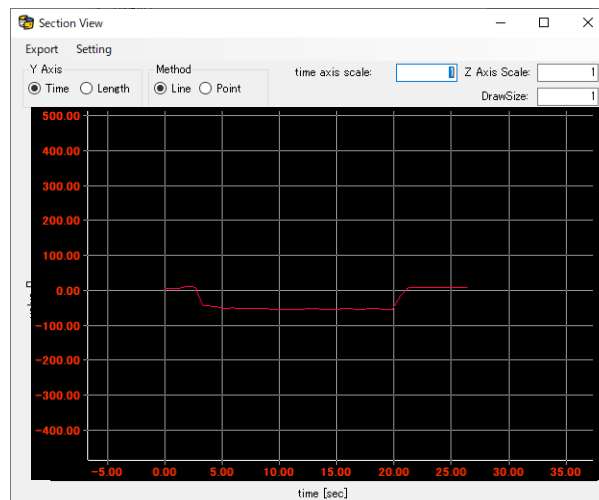

Information and Settings of cross sections

Checking the position of the cross section and setting whether to display or hide the cross section in the [List of Cross Sections] (lower right diagram) of the [Graph Control Area].

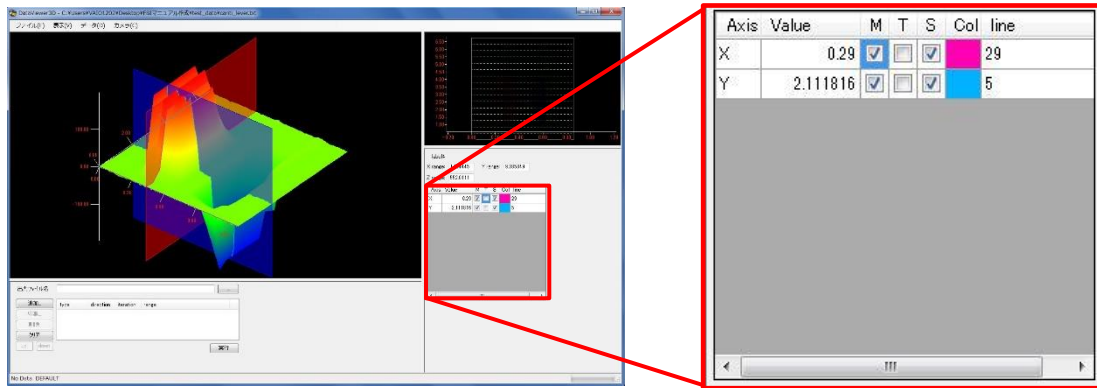

- [Axis] X : Displays the cross section in the length direction (X-Z).
 Y : Displays the cross section in the time direction (Y-Z).
- [Value] X : The position where the cross section is cut in the length of the fiber.
 Y : The position where the cross section is cut in the measurement time direction.
- [M(Main)] : Show/Hide in "3D Area"
 [T(Top)] : "Display/hide in 2D area"
 [S(Section)] : Show or hide in the Section View window.
 [Col(Color)] : Color of cross section
 [Line] : Matrix number of measurement data (X: Column/Y: Row)

Movement of cross section display

When the displayed cross section is left-clicked, the cross section is selected and its color changes. Right-click and select Move Section. Move the mouse without pressing anything to move the cross section.

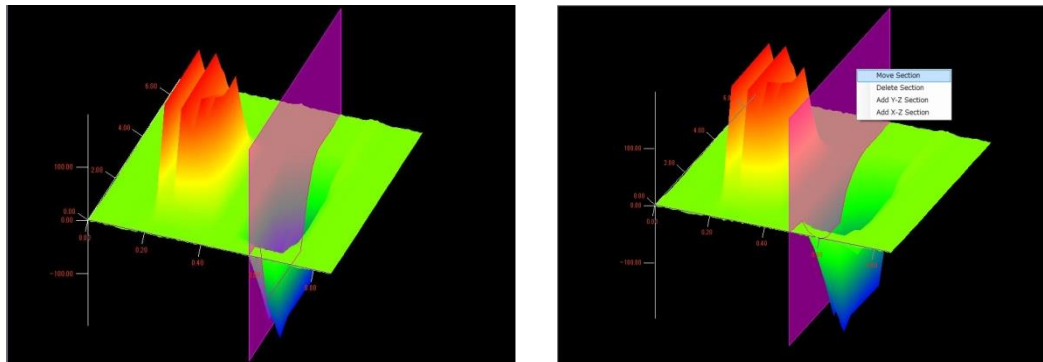

To determine the cross-section position, left-click the black background in the 3D area to change the cross section color to red, which is determined. If you decide the position, the cross-section will not move.

BMP (Image) Output of Cross Section Graph

Clicking [Export]→[Image] → [Bmp] in the menu bar in the cross section graph window allows you to specify the output destination and output the graph images in.bmp format.

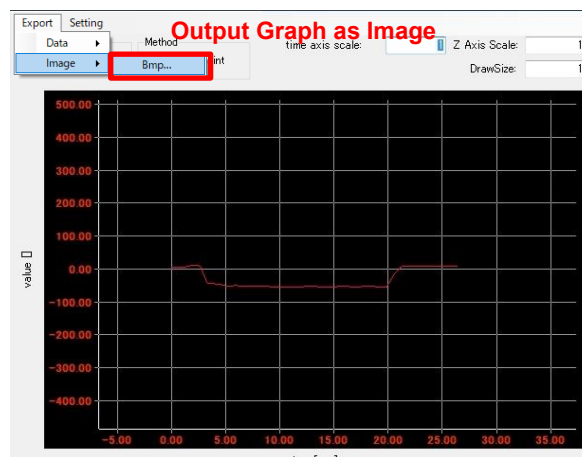

CSV and TXT (Text) Output for Cross Section Graphs

From the menu bar in the cross section graph window, click [Export] → [Data] → [Csv.] or [Text.] to specify the output destination and output the numerical data of the graph in .csv format or .txt format.

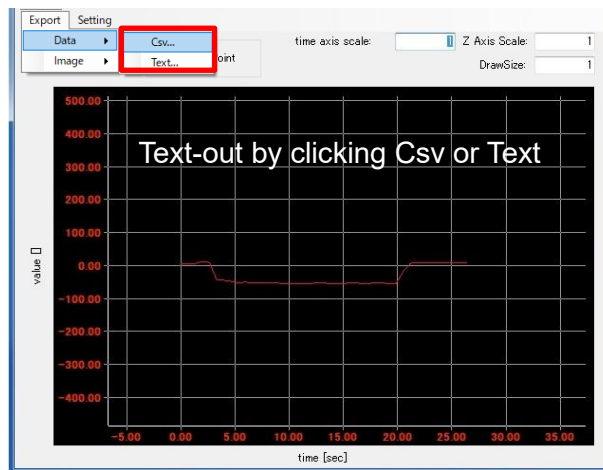

Changing the Graph Format (Lines and Points)

You can select the display style of the graph from the lines and dots.

Line : Line display

Point : Point indication

You can change the line thickness and point size by entering a numeric value in [DrawSize].

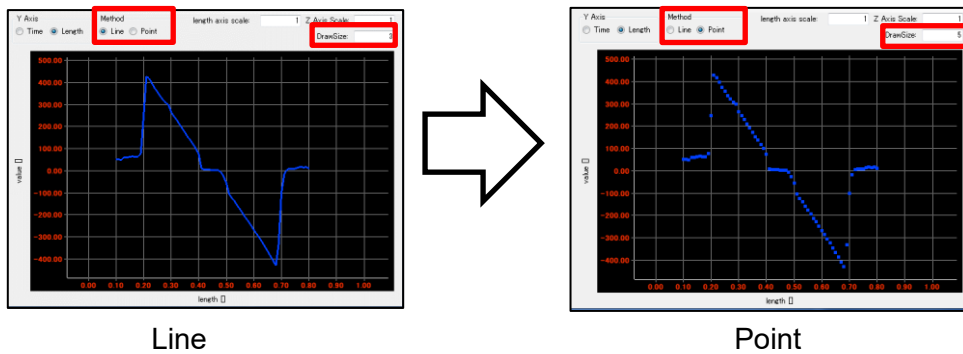

Axis Label Change (Display of Axis Label Name)

Set the name and whether to show or hide the axis labels in the Section View window.

Clicking [Setting]→[Axis Label] in the [Section View] window displays the setting window.

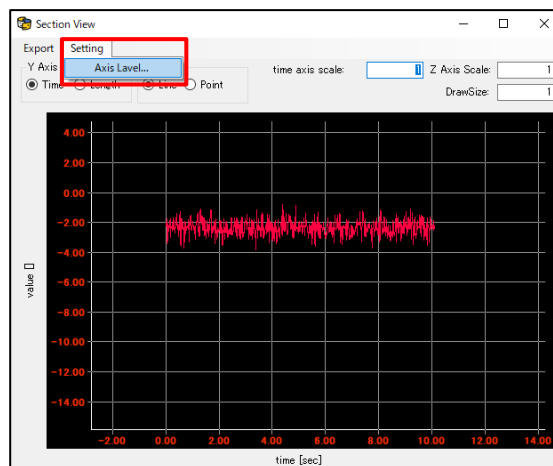

Checking [Visible] in the [Axis Label Setting Window] displays the name of the axis label in the cross section graph.

Entering a label name in Axis Label in the Axis Label Setting Window changes the name of the axis label.

Section Graph Axis Label Setting

Length :
 Visible Tics : 2 [px]
Axis Label : Length

Time :
 Visible Tics : 2 [px]
Axis Label : Time

Value :
 Visible Tics : 100 [px]
Axis Label : micro strain
 Rotates 90 Degrees Counter Clockwise

Font...
Background Color... [Black] [Close]

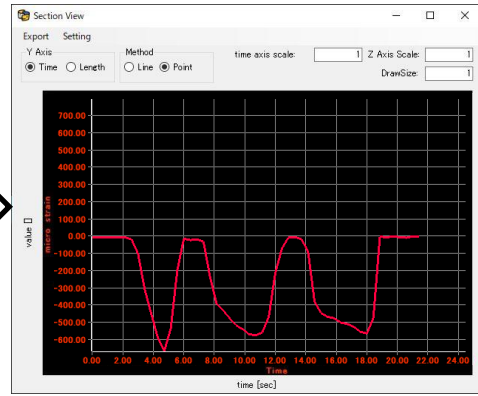
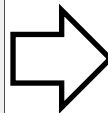
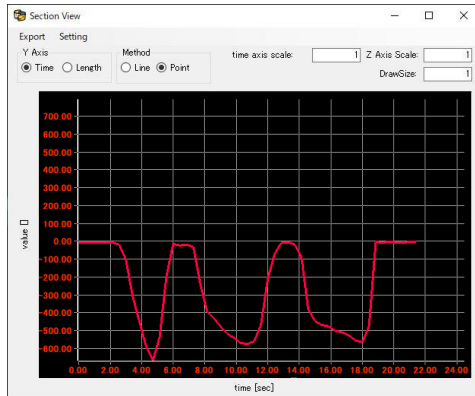

When [Rotate 90 degrees counter clockwise] is checked, the values are rotated by 90 degrees.

Axis Label Change (Memory Interval)

From the Axis Label Setting Window, set the scale spacing for the axis labels.

Click Setting]→[Axis Label in the Section View window to open the Axis Label Setting Window.

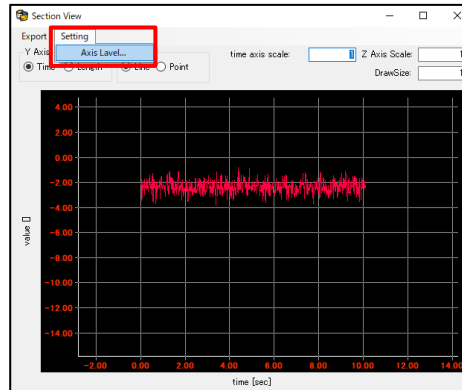

You can change the scale intervals of the axis labels by entering a number in [tics] of [Axis Label Setting Window].

When [px] is checked, the [tics] values switch to pixel-by-pixel displays.

The 'Axis Label Setting' dialog box is shown. It has three sections: 'Length', 'Time', and 'Value'. Each section has a 'Visible' checkbox (checked), an 'Axis Label' text field (containing 'AxisLabel[]'), a 'Tics' field (set to 40), and a '[px]' checkbox (checked). At the bottom, there are buttons for 'Font...', 'Background Color...' (with a black color swatch), and 'Close'.

6.6. Adding points

By adding a point on the three-dimensional graph, you can measure the distance between two points, display the cross section on the point, and set the rotation center.

6.6.1. Point selection

You can add points by selecting Add Point in the Data menu bar or by clicking Ctrl and left-clicking on the three-dimensional graph. The selected point turns blue and the other points turn purple.

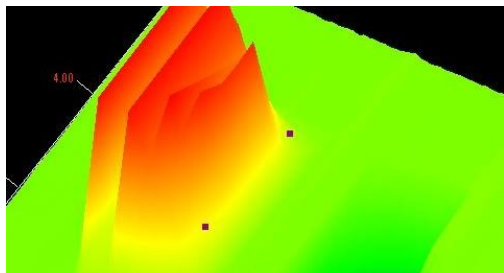

6.6.2. Point selection menu

Right-click an added point to select it and turn it to blue and display the menu.

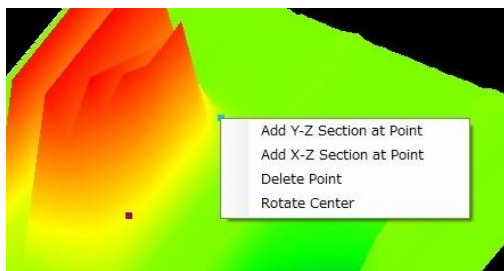

- | | |
|----------------------------|------------------------------------------------|
| [Add Y-Z Section at Point] | : Create a cross section in the Y-Z direction. |
| [Add X-Z Section at Point] | : Create a cross section in the X-Z direction. |
| [Delete Point] | : Deletes a point. |
| [Rotate Center] | : Set to the rotation center. |

6.6.3. Distance between two points

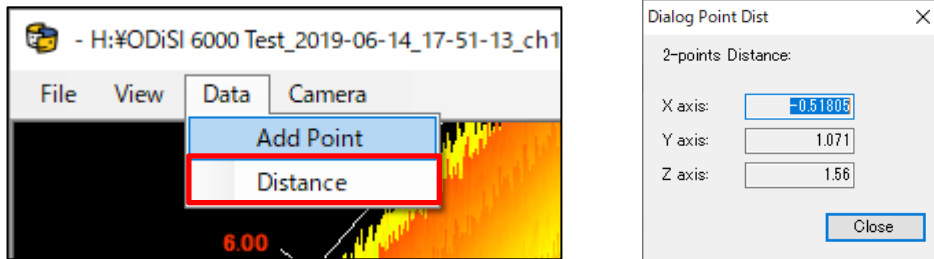

With the two points you want to be distanced, select Data]→[Distance on the menu bar, and select the two points with Left-Click. The reference point changes to blue, and if you select another point, a window is displayed, showing the dimensions in the X-axis Y-axis Z-axis direction.

6.7. Filter function

F3D filters can read text data in ODiSI format (.tsv) and filter out the text data under certain conditions. Filtered data can be printed in text data (.txt) or in CSV files (.csv). Filters act on each point depending on its value and its relationship to surrounding values. Filtered history remains at the beginning of the file.

Cutoff	Removes data that is outside the specified threshold and linearly interpolates between previous and next time values
Median	For each point in the two-dimensional data, sort the values in the specified range around the point in order of size, and apply the value (median) of the point in the center.
Short Wavelength Cut	Removes frequency components higher than the specified frequency. This can be set in either the temporal or spatial directions.
Change cutoff	If the value changes by more than the specified amount of change compared to the previous value, the previous amount of change is applied.

6.7.1. Viewing the Filter Dialog

When using the filter function, select [Add] in [Filter Areas] to open the [Filter Control] dialogue box.

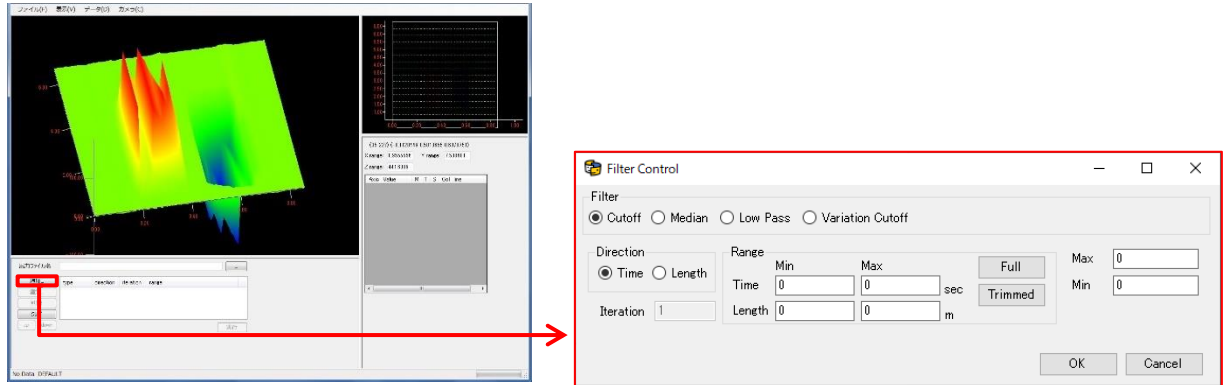

- [Cutoff] : Switches to the cutoff filter.
- [Median] : Switches to median filter.
- [Low Pass] : Switches to the short wavelength cut filter.
- [Variation Cutoff] Change: Changes to the cutoff filter.

- [Direction] : Specify the filter direction (not required for Median)
- [Iteration] : Specify to overlay similar filters (short wavelength)
Not required for cuts.)
- [Range] : specifies the range to filter.
- [Full] : The range is adjusted to the entire range of the measurement data.
- [Trimmed] : Fits the range to the specified range in the 2D area.

- [max] : Depends on the filter.
Refer to each filter page.
- [min] : Depends on the filter.
Refer to each filter page.

6.7.2. Cut-off filter

The cutoff filter traverses the data at each fiber position in chronological order, deletes data outside the specified threshold, and linearly interpolates between the previous and next values. This is used when the value of the generated noise is far from the actual value.

6.7.2.1. Cut-off Filter Settings

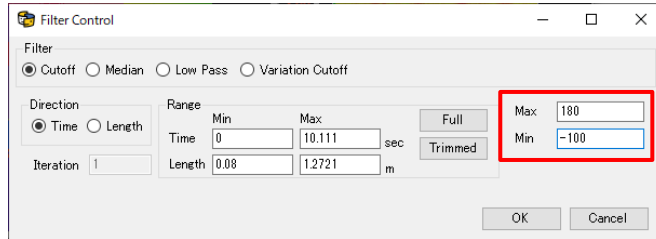

[max] : Upper threshold. Points above this value are cut-off studies.

[min] : Lower threshold. The points below this value are the cutoff targets.

Example

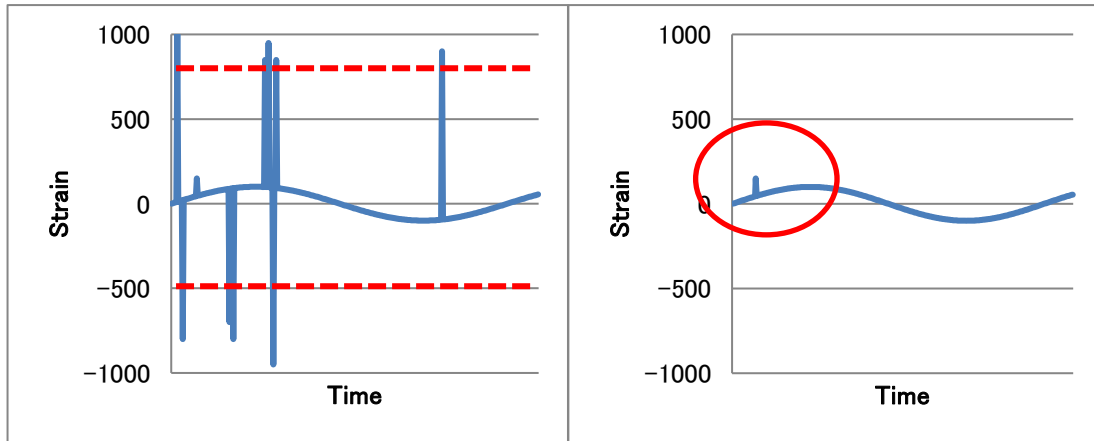

Graph at left :Raw Data

Graph to the right : Filtered Data (min = -500,max = 800)

Large noise is eliminated, but values within the threshold are left as they are.

6.7.3. Median filter

The median filter is a technique often used for image processing, which looks at the values in a specified range around each point in two-dimensional data, sorts the values in order of size, and applies the values (median) of the points located in the center of the sorted values. This process eliminates noise that can cause extreme values to appear at only one point.

6.7.3.1. Median Filter Settings

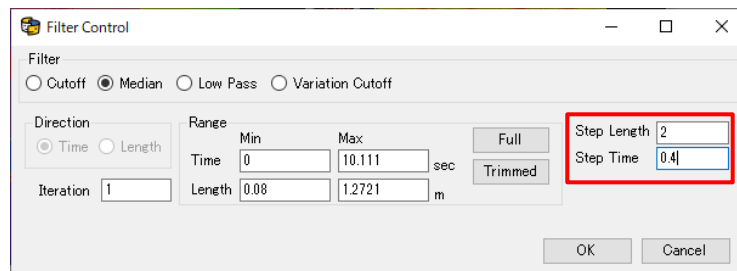

[Step Length] : specifies the target range for the length direction. In the case of [2], the target data ± 2

A total of five data items are available.

[Step Time] : specifies the range of interest in the time direction.

Median filter example

The following is a case where the values are applied around a certain point with a value of 1024 and within the range of 1 before and after each point in the time direction. This range of data is ordered 1.1, 2.2, 2.3, 2.5, 4.3, 5.4, 5.5, 6.4, 1024.0, and is replaced by the fifth data 4.3, which is the center of the nine data.

1.1	5.4	2.3
2.5	1024.0	6.4
4.3	2.2	5.5

Before
application

1.1	5.4	2.3
2.5	4.3	6.4
4.3	2.2	5.5

After
application

6.7.4. Short Wavelength Cut Filter

A short cut filter is a filter that removes frequency components that are higher than the specified frequency and is suitable for removing fine noise. A low-pass filter is also called a low-pass filter to transmit a long wavelength.

6.7.4.1. Configuring Short Wavelength Cut Filters

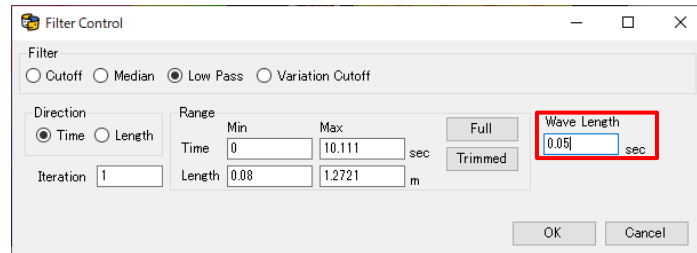

[Wavelength] Specifies the length of the wavelength that will be the threshold. For wavelengths shorter than this wavelength
 You reduce.

Example of Short Wavelength Cut Filter

The following data is obtained by applying the short wavelength cut filter of 0.05sec, 0.1sec, and 0.5sec.

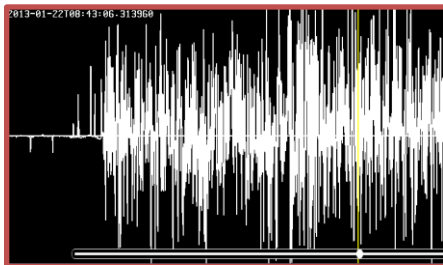

Original data

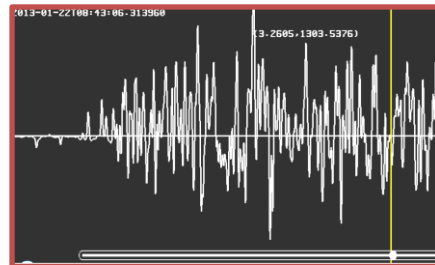

0.05 sec filter

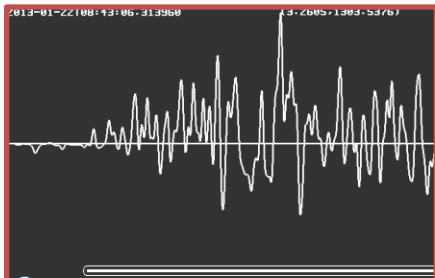

0.1sec filter



0.5sec filter

6.7.5. Change cutoff filter

Variation cutoff filter uses the amount of change in the measurement data as a threshold value to reduce noise for portions having a sudden change. It is suitable for eliminating small pulse noise in large changes.

6.7.5.1. Change Cutoff Filter Settings

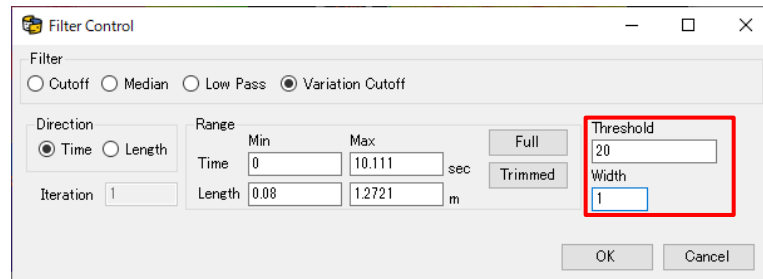

[Threshold] : Change threshold.

[Width] : Target data length.

Determines whether the amount of change between these lengths is within the threshold. Data subject to noise is deleted, and linear interpolation is performed from neighboring values

Example of Variation Cut-Off Filter

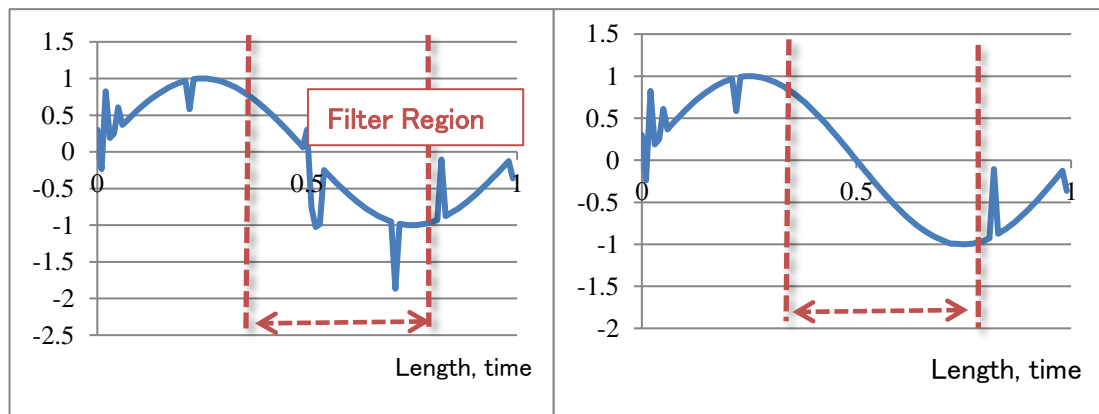

In this case, the filters are applied four times repeatedly, with the temporal change being threshold=0.1 and 0.3 - 0.8sec selected in the 2D area. Only noise within the range has been removed.

6.7.6. Saving Filter Data

In the Filter Control dialogs for filter settings, the set filter is registered in the filter area. You can create multiple filters in the Filters area, and when you execute them, they are filtered in order from the beginning.

6.7.6.1. Procedure for saving filter data

Enter an output filename in [Output Filename] and select [Run] to perform filtering and save the data obtained by filtering. After saving, the 3D graph with the new data starts.

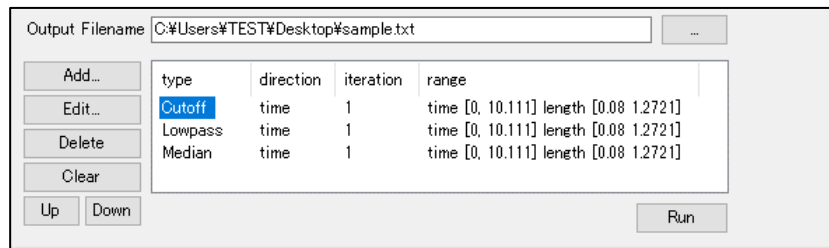

[Output Filename] : Enter the folder name and file name to save. The output file is a text file (.txt) or a CSV file (.csv).

[Add] : Add a new filter.

[Edit] : Edits the filter selected in the filter area.

[Delete] : Deletes the filter selected in the Filters area.

[Clear] : Deletes all filters in the filter area.

Up / Down : Changes the order of the selected filters. Filters usually come from top to bottom.

[Run] : Executes the filter, outputs the file, and launches a new three-dimensional graph.

7. Temperature Conversion Tool

The F3D Temperature Conversion Tool (Spectral Shift to Temperature Tool) is an application tool that aims to convert spectral shift measurement data into temperature data.

By converting the measurement data of spectral shift to temperature using the tool's unique temperature coefficient, it is able to output appropriate temperature. It is also useful when you perform temperature compensated measurements.

7.1. Launch Temperature Conversion Tool

Right-click in the F3D 3Dviz Model View area and click Launch SpectralShift to Temperature Tool.

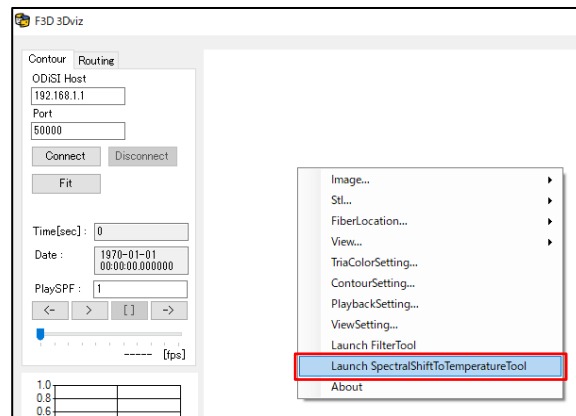

The temperature conversion tool consists of six parts: "input file", " output file", "fiber type", "reference temperature", "force processing selection" and "Run button".

You can also check the software version by clicking "About" in the upper left corner.

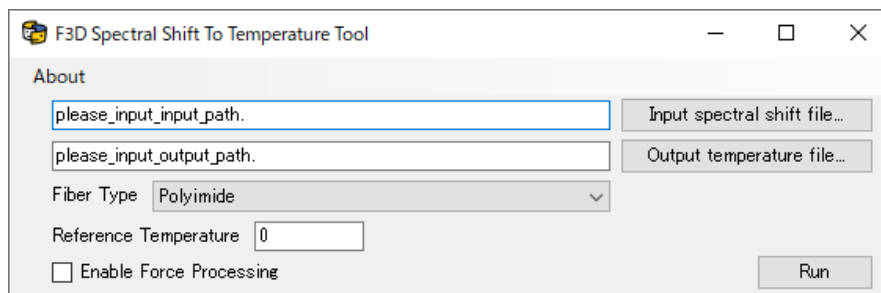

7.2. Select input data

Click [Input spectral shift file ...] and select the Spectral shift measurement file that you want to convert to temperature.

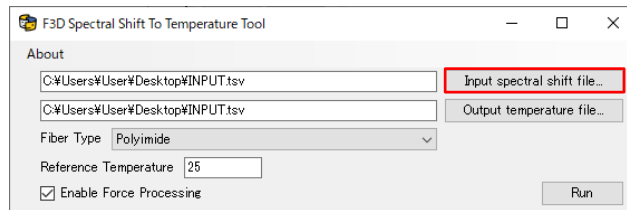

There are three types of measurement data that can be specified: TSV file, text file, and CSV file. Use the data exported from ODiSI controller for TSV files, and the data exported from F3D Filter Tool for text files and CSV files.

7.3. Select output destination

Click [Output temperature file ...] and specify the output destination and file name of the measurement data converted to temperature.

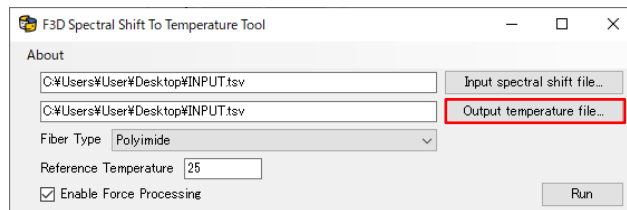

The output file format can be specified from two types, text file and CSV file.

7.4. Select Fiber Type

Select Polyimide if using polyimide coated fiber in the Fiber Type pull-down menu, or select Gold if using gold coated fiber.

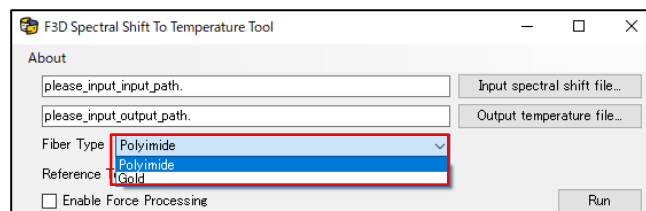

7.5. Enter Reference Temperature

Enter the reference temperature in [Reference Temperature]. The unit is Celsius.

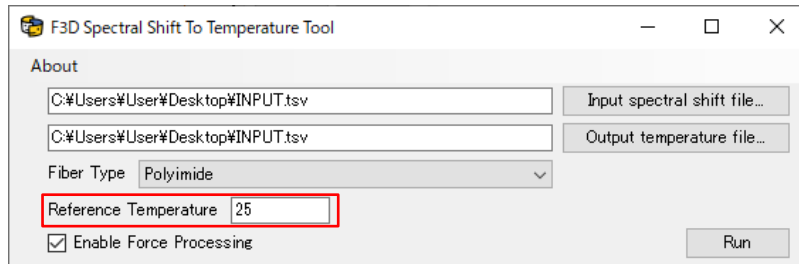

Enter the ambient temperature at the start of normal measurement as the reference temperature. If you want to know only the amount of temperature change, enter 0.

Note:

The temperature coefficients used in this tool is the best match when the reference temperature is approximately 25 degrees Celsius.

7.6. Run Conversion Process

Click Run to start the conversion process and a message will appear when the process is complete.

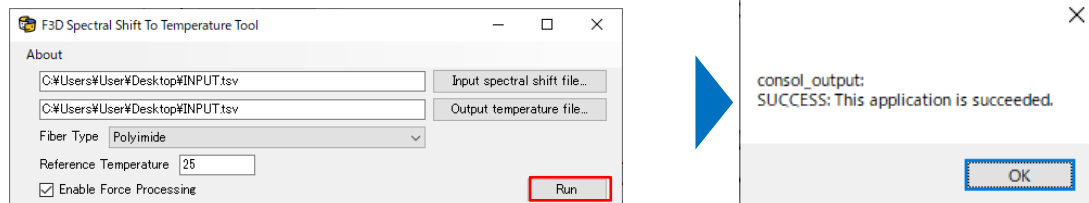

Note:

When [Enable Force Processing] is checked, if the input file contains "NAN", NAN is replaced with a very large value (about $10e+38$) to perform automatic conversion.

Software update log

V2.0.0 change

Change the GUIs in the FBI-G Main Window
Modify the Filter Tool and Temperature Conversion Tool to Start From the Menu Tab
Change Shortcut Buttons
Adding the Save and Read Views Function
Addition of STL Temperature Interpolation Contour Display Function
Eliminate numerical adjustments by wheel to input text (Contour Up/Down Limit, Fiber Position, Fiber Width, etc.)
Change fiber position data extension from.txt to.fld
Supports measurement result files containing "1.#QNAN" outputted from the ODiSI-B.
The filter tool supports measurement result files with unequal time intervals.
Fixed a Bug in the Filter Tool where the Delete Last Row Duplicate Operation Does Not Delete the Last Row (Filter Tool)
Modified so that the interpolated values of the cut-off filter and the change amount cut-off filter become values depending on the distance.
Fixed a bug that dropped when the drawing screen was narrowed
Addition of cross section graph csv output function in the filter tool

V2.0.1 Changes

Change the coefficients for polyimide fiber in the temperature conversion tool.
Enables you to select either fixed-value substitution or pre-and-post interpolation when reading measurement result files containing "1.#QNAN" from the ODiSI-B.
Changing
Temperature-conversion tools add forced run options for measurement result files containing last line duplicates and 1.#QNAN.

V2.0.2 Changes

Change the scale setting for a graph in the Filter tool
Add movie output function (.avi)

V2.0.3 Changes

Supports 100MB or more files for reading ODiSI measurement data

V2.0.4 Changes

Added size fixation function for model view

Image Format and Image Size Settings for Continuous Image Output

Add compression setting in movie power

Addition of cross section graph txt output function in the filter tool

Change the low-pass filter to continuous executable.

V3.0.0 change

Supports ODiSI 6100 Series

Add Fiber Route Settings and Output Modes

V3.0.1 Changes

Fixed Fiber Route Configuration Listing

V3.0.2 Changes

Added function to interpolate fiber position information

V3.1.0 Changes

Add 2D Contour Function to 3Dviz

Changed to transparently show NANs in 3Dviz

Changes to allow you to select the type of contour in the 3Dviz (HSV, JET, HOT, COLD)

Adding a Contour Bar view in the 3Dviz

Changed to ignore NANs when fitting in 3Dviz graphs

Supports ODiSI 6100 v1. 6 outputs

Supports measurement data for a plurality of channels in 3Dviz

Play Back function and movie creation function are added to 3Dviz.

Supports binary STL data

Addition of saving and loading of View in 3Dviz

Changed so that view operations cannot be performed while Ctrl keys are pressed on the 3Dviz.

Fixed a bug when creating fiber routes

Change licensing system

V3.1.1 Changes

Supports tsv files exported by ODiSI v1. 6.1

V3.2 Changes

Conversion tool is added. (SpectralShift to Temperature Tool)

V3.2.1 Changes

Fixed a bug related to data reading during real-time visualization

V3.3 Changes

Added transparency and wireframe display to Tria Setting

Fixed a bug related to real time measurement data plotting